

 ADDISON



Caledonian

Caledonian Railway Cables

TRACTION CABLES & HIGH TEMPERATURE
CABLES FOR RAILWAY APPLICATION

www.caledonian-cables.co.uk
www.addison-cables.com



COMPANY PROFILE

Caledonian & Addison, established in 1978, produced a wide range of copper and fiber optic cables for communication, power and electronics in its 2 plants in UK and 5 plants in China. Caledonian products are sold in more than 35 countries around the globe.

Our extensive global network of manufacturing facilities gives us significant scale and the flexibility to fulfill our customer requirements. This global presence provides design and consultancy solutions that are combined with core cable manufacturing and logistics services, and vertically integrated with our E commerce technologies, to optimize customer operations by lowering costs and reducing time to market.

Caledonian & Addison has been respected for its high standards of quality, excellent service level, competitive pricing and a unique and innovative spirit. With our latest technologies, we are both inspired and well-positioned to meet the changing needs of our customers. We have the resources to diversify and to enhance our product lines and services. We understand the need for change and with our accurate planning we are ready for the future and the promise of new marketing opportunities. Our tradition of growth through excellence is assured.

Our Design Centers work closely with customers to constantly improve its standard range of products and technologies and to develop customized, country and industry-specific solutions. Caledonian has established an extensive network of design, manufacturing, and logistics facilities in the world's major markets to serve the growing outsourcing needs of both multinational and regional customers.



Caledonian
www.caledonian-cables.co.uk



ADDISON
www.addison-cables.com



CONTENT

TRACTION CABLES FOR RAILWAY APPLICATION

GKW-RW 300/500V Thin Wall Single Core	1
GKW-RW/S 300/500V Thin Wall Multicore	3
GKW-RW/S EMC 300/500V Thin Wall Screened Multicore	5
3GKW-RW 0.6/1KV Thin Wall Single Core	7
3GKW-RW/S 0.6/1KV Thin Wall Multicore	9
3GKW-RW/S EMC 0.6/1KV Thin Wall Screened Multicore	11
3GKW-SW 0.6/1KV Standard Wall Single Core	13
3GKW-SW/S 0.6/1KV Standard Wall Multicore	15
3GKW-SW/S EMC 0.6/1KV Standard Wall Screened Multicore	17
3GKW-DW 0.6/1KV Dual Wall Single Core	19
3GKW-DW/S 0.6/1KV Dual Wall Multicore	21
3GKW-DW/S EMC 0.6/1KV Dual Wall Screened Multicore	23
4GKW-AXplus-DW 1.8/3KV Dual Wall Single Core.....	27
4GKW-AXplus-DW EMC 1.8/3KV Dual Wall Screened Single Core	29
4GKW-AXplus-DW/S EMC 1.8/3KV Dual Wall Screened Multicore	31
9GKW-AXplus-DW 3.6/6KV Dual Wall Single Core.....	33
9GKW-AXplus-DW EMC 3.6/6KV Dual Wall Screened Single Core	35
GKW-RW FE180 300/500V Thin Wall Single Core	37
3GKW-SW FE180 0.6/1KV Standard Wall Single Core	39
4GKW-AXplus-DW FE180 1.8/3KV Dual Wall Single Core	41



HIGH TEMPERATURE CABLES FOR RAILWAY APPLICATION

FRA 145 Single Core	43
FRA 145/S Multicore	45
FRA 145/S EMC Screened Multicore	48
FRA 155 Single Core	51
FRA 155S Oil Resistant Single Core	53
FRA 155/S Multicore	55
FRA 155/S EMC Screened Multicore	57

ORDERING INFORMATION

Ordering Information For GKW Cables	59
Ordering Information For High Temperature Cables	59



GKW-RW 300/500V Thin Wall Single Core

Applications

Single core power and control cable designed for protected, fixed installation inside and outside railway vehicles for connecting fixed and moving parts in direct current and alternating voltage technology, especially converter technology.



Standard

- BS 6853 -1a
- DIN 5510-2 1-4
- NFF 16-101 F0

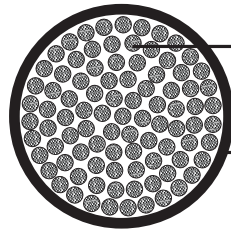

Stranded Tinned Copper Conductor

Electron Beam Crosslinkable LSZH Insulation

Construction

- **Conductors:** Circular Class 5 stranded tinned copper to IEC60228/VDE 0295.
- **Insulation:** Electron beam crosslinkable LSZH compound.

Electrical Characteristics at 20°C

Nominal Conductor Cross Section	mm ²	0.5	0.75	1	1.5	2.5
Maximum Conductor Resistance	Ω/km	40.1	26.7	20.0	13.7	8.21
Voltage Rating	KV	0.3/0.5				

Mechanical and Thermal Properties

Minimum Bending Radius: 4xOD (Static); 6xOD (Flexing)
 Temperature Range: -40°C ~+120°C (Static); -35°C ~+90°C (Flexing)
 Short Circuit Temperature: +280°C



Dimensions and Weight

No. of cores & Nominal Conductor Cross Sectional Area No. x mm ²	Number and Nominal Diameter of Strands No/mm	Nominal Insulation Thickness mm	Nominal Overall Diameter mm	Nominal Weight kg/km
1x0.5	16/0.20	0.18	1.3	6
1x0.75	24/0.20	0.18	1.56	9
1x1.0	32/0.20	0.18	1.7	12
1x1.5	30/0.25	0.22	2.04	17
1x2.5	50/0.25	0.28	2.66	27



Impact Resistant



Highly Flexible

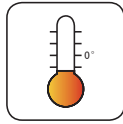

Cold Resistant

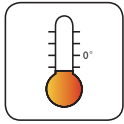

Soldering Heat Resistant



IRM 903 Fuel Oil Resistant



IRM 902 Mineral Oil Resistant

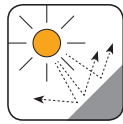

UV Resistant

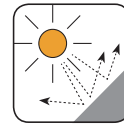

Ozone Resistant



Acid and Alkali Resistant



Fire Retardant
NF C32-070-2.2(C1)
IEC 60332-3/EN50266



Flame Retardant
NF C32-070-2.1(C2)
IEC 60332-1/EN 50265-2-1



Low Corrosivity
EN 50267-2-2/NF C32-074
IEC 60754-2/NF C20-453



Low Toxicity



Low Smoke Emission
IEC 61034/NFC20-902
EN 50268/NF C32-073

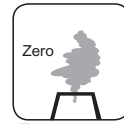

Zero Halogen
IEC 60754-1/NF C20-454
EN 50267-2-1



GKW-RW/S 300/500V Thin Wall Multicore

Applications

Multi core power and control cable designed for protected, fixed installation inside and outside railway vehicles for connecting fixed and moving parts in direct current and alternating voltage technology, especially converter technology.



Standard

- BS 6853 -1a
- DIN 5510-2 1-4
- NFF 16-101 F0

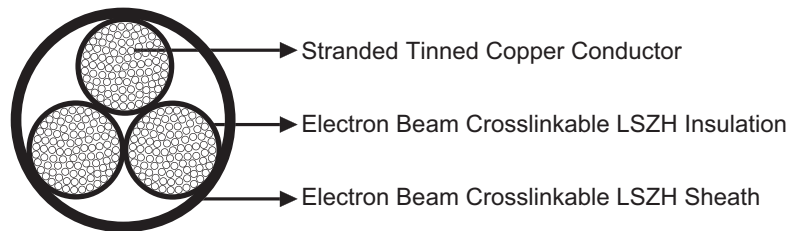

Construction

- **Conductors:** Circular Class 5 stranded tinned copper to IEC60228/VDE 0295.
- **Insulation:** Electron beam crosslinkable LSZH compound.
- **Sheath:** Electron beam crosslinkable LSZH compound.

Electrical Characteristics at 20°C

Nominal Conductor Cross Section	mm ²	0.5	0.75	1	1.5	2.5
Maximum Conductor Resistance	Ω/km	40.1	26.7	20.0	13.7	8.21
Voltage Rating	KV	0.3/0.5				

Mechanical and Thermal Properties

Minimum Bending Radius: 4xOD (Static); 6xOD (Flexing)
 Temperature Range: -60°C ~+120°C (Static); -40°C ~+90°C (Flexing)
 Short Circuit Temperature: +280°C



Dimensions and Weight

No. of cores & Nominal Conductor Cross Sectional Area No. x mm ²	Number and Nominal Diameter of Strands No/mm	Nominal Insulation Thickness mm	Nominal Overall Diameter mm	Nominal Weight kg/km
2x0.5	16/0.20	0.18	4.5	29
3x0.5	16/0.20	0.18	4.6	36
4x0.5	16/0.20	0.18	5.0	44
5x0.5	16/0.20	0.18	5.4	52
6x0.5	16/0.20	0.18	5.9	59
7x0.5	16/0.20	0.18	6.4	71
8x0.5	16/0.20	0.18	6.8	81
2x0.75	24/0.20	0.18	4.8	37
3x0.75	24/0.20	0.18	5.1	48
4x0.75	24/0.20	0.18	5.6	58
5x0.75	24/0.20	0.18	6.1	69
6x0.75	24/0.20	0.18	6.7	81
7x0.75	24/0.20	0.18	7.1	93
8x0.75	24/0.20	0.18	7.7	108
16x0.75	24/0.20	0.18	9.5	175
18x0.75	24/0.20	0.18	10.1	198
2x1.0	32/0.20	0.18	5.2	45
3x1.0	32/0.20	0.18	5.5	59
4x1.0	32/0.20	0.18	6.2	73
5x1.0	32/0.20	0.18	6.7	87
12x1.0	32/0.20	0.18	9.4	174
2x1.5	30/0.25	0.22	6.0	59
3x1.5	30/0.25	0.22	6.4	81
4x1.5	30/0.25	0.22	7.1	99
5x1.5	30/0.25	0.22	7.7	123
6x1.5	30/0.25	0.22	8.5	143
7x1.5	30/0.25	0.22	9.1	163
8x1.5	30/0.25	0.22	9.8	192
10x1.5	30/0.25	0.22	10.5	215
12x1.5	30/0.25	0.22	11.1	244
16x1.5	30/0.25	0.22	12.3	326
2x2.5	50/0.25	0.28	7.1	89
3x2.5	50/0.25	0.28	7.4	117
4x2.5	50/0.25	0.28	8.3	150
5x2.5	50/0.25	0.28	9.1	182



Impact Resistant



Highly Flexible

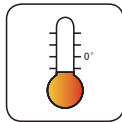

Cold Resistant



Soldering Heat Resistant



Low Temperature Resistant



Corona Resistant



Fire Retardant

NF C32-070-2.2(C1)

IEC 60332-3/EN50266



Flame Retardant

NF C32-070-2.1(C2)

IEC 60332-1/EN 50265-2-1



Low Corrosivity

EN 50267-2-2/NF C32-074

IEC 60754-2/NF C20-453



IRM 903 Fuel Oil Resistant



IRM 902 Mineral Oil Resistant



UV Resistant

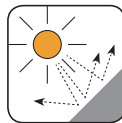

Ozone Resistant



Acid and Alkali Resistant

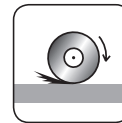

Abrasion Resistant



Low Smoke Emission

IEC 61034/NFC20-902

EN 50268/NF C32-073



Low Toxicity

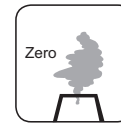

Zero Halogen

IEC 60754-1/NF C20-454

EN 50267-2-1





GKW-RW/S EMC 300/500V Thin Wall Screened Multicore

Applications

Multi core power and control cable designed for protected, fixed installation inside and outside railway vehicles for connecting fixed and moving parts in direct current and alternating voltage technology, especially converter technology.



Standard

- BS 6853 -1a
- DIN 5510-2 1-4
- NFF 16-101 F0

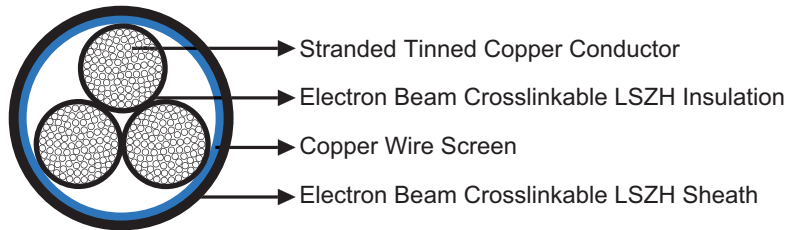

Construction

- **Conductors:** Circular Class 5 stranded tinned copper to IEC60228/VDE 0295.
- **Insulation:** Electron beam crosslinkable LSZH compound.
- **Screen:** Copper wire screen.
- **Sheath:** Electron beam crosslinkable LSZH compound.

Electrical Characteristics at 20°C

Nominal Conductor Cross Section	mm ²	0.5	0.75	1	1.5
Maximum Conductor Resistance	Ω/km	40.1	26.7	20.0	13.7
Voltage Rating	KV	0.3/0.5			

Mechanical and Thermal Properties

Minimum Bending Radius: 4xOD (Static); 8xOD (Flexing)
 Temperature Range: -60°C ~+120°C (Static); -40°C ~+90°C (Flexing)
 Short Circuit Temperature: +280°C



Dimensions and Weight

No. of cores& Nominal Conductor Cross Sectional Area No.×mm ²	Number and Nominal Diameter of Strands No/mm	Nominal Insulation Thickness mm	Nominal Overall Diameter mm	Nominal Weight kg/km
2×0.5	16/0.20	0.18	4.8	31
3×0.5	16/0.20	0.18	5.0	43
4×0.5	16/0.20	0.18	5.4	50
5×0.5	16/0.20	0.18	6.1	58
6×0.5	16/0.20	0.18	6.5	77
10×0.5	16/0.20	0.18	7.7	111
12×0.5	16/0.20	0.18	8.1	128
14×0.5	16/0.20	0.18	8.6	140
27×0.5	16/0.20	0.18	11.1	238
2×2×0.5	16/0.20	0.18	7.1	89
3×2×0.5	16/0.20	0.18	7.5	103
4×2×0.5	16/0.20	0.18	8.2	130
2×0.75	24/0.20	0.18	5.3	46
3×0.75	24/0.20	0.18	5.6	55
4×0.75	24/0.20	0.18	6.2	63
6×0.75	24/0.20	0.18	7.4	105
7×0.75	24/0.20	0.18	7.7	119
8×0.75	24/0.20	0.18	8.3	137
12×0.75	24/0.20	0.18	9.3	168
16×0.75	24/0.20	0.18	9.8	187
2×2×0.75	24/0.20	0.18	8.0	100
2×1.0	32/0.20	0.18	5.9	63
3×1.0	32/0.20	0.18	6.2	75
4×1.0	32/0.20	0.18	6.8	89
5×1.0	32/0.20	0.18	7.3	108
12×1.0	32/0.20	0.18	10.0	209
2×2×1.0	32/0.20	0.18	8.9	116
2×1.5	30/0.25	0.22	6.7	80
3×1.5	30/0.25	0.22	7.1	98
4×1.5	30/0.25	0.22	7.6	118
5×1.5	30/0.25	0.22	8.3	144
6×1.5	30/0.25	0.22	9.1	170
12×1.5	30/0.25	0.22	11.7	285



Impact Resistant



Highly Flexible



Cold Resistant

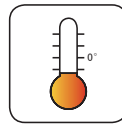

Soldering Heat Resistant

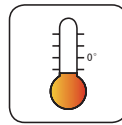

Low Temperature Resistant



Corona Resistant



Fire Retardant
NF C32-070-2.2(C1)
IEC 60332-3/EN50266



Flame Retardant
NF C32-070-2.1(C2)
IEC 60332-1/EN 50265-2-1



Low Corrosivity
EN 50267-2-2/NF C32-074
IEC 60754-2/NF C20-453



IRM 903 Fuel Oil Resistant



IRM 902 Mineral Oil Resistant

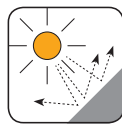

UV Resistant

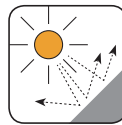

Ozone Resistant



Acid and Alkali Resistant

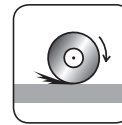

Abrasion Resistant



Low Smoke Emission
IEC 61034/NFC20-902
EN 50268/NF C32-073



Low Toxicity

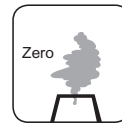

Zero Halogen
IEC 60754-1/NF C20-454
EN 50267-2-1





3GKW-RW 0.6/1KV Thin Wall Single Core

Applications

Single core power and control cable designed for protected, fixed installation inside and outside railway vehicles for connecting fixed and moving parts in direct current and alternating voltage technology, especially converter technology.



Standard

- BS 6853 -1a
- DIN 5510-2 1-4
- NFF 16-101 F0

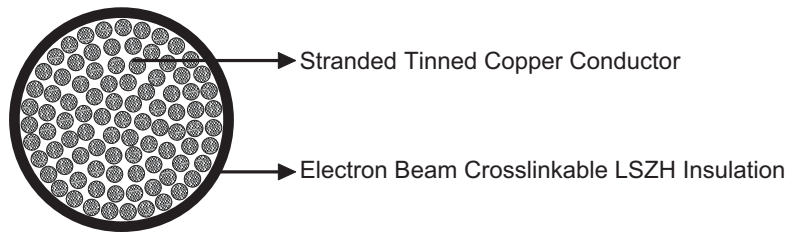

Construction

- **Conductors:** Circular Class 5 stranded tinned copper to IEC60228/VDE 0295.
- **Insulation:** Electron beam crosslinkable LSZH compound.

Electrical Characteristics at 20°C

Nominal Conductor Cross Section	mm ²	0.5	0.6	0.75	1	1.2	1.5	2.0	2.5	3	4.0
AWG			20		18	16		14		12	
Maximum Conductor Resistance	Ω/km	40.1	31.1	26.7	20.0	15.5	13.7	10.5	8.21	6.56	5.09
Voltage Rating	KV	0.6/1									

Mechanical and Thermal Properties

Minimum Bending Radius: 4xOD (Static); 6xOD (Flexing)
 Temperature Range: -40°C ~+120°C (Static); -35°C ~+90°C (Flexing)
 Short Circuit Temperature: +280°C



Dimensions and Weight

No. of cores & Nominal Conductor Cross Sectional Area No. × mm ²	Number and Nominal Diameter of Strands No/mm	Nominal Insulation Thickness mm	Nominal Overall Diameter mm	Nominal Weight kg/km
1×0.5	16/0.20	0.3	1.40	6
1×0.6	19/0.20	0.3	1.50	7
1×0.75	24/0.20	0.3	1.60	8.3
1×1.0	32/0.20	0.3	1.73	11
1×1.2	19/0.28	0.3	2.00	13
1×1.5	30/0.25	0.3	2.14	16
1×2.0	37/0.25	0.4	2.40	19
1×2.5	50/0.25	0.4	2.70	26
1×4	56/0.30	0.4	3.35	40



Impact Resistant



Highly Flexible



Cold Resistant



Soldering Heat Resistant



IRM 902 Mineral Oil Resistant

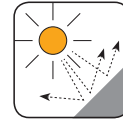

UV Resistant

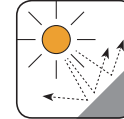

Ozone Resistant



Acid and Alkali Resistant



Fire Retardant
NF C32-070-2.2(C1)
IEC 60332-3/EN50266



Flame Retardant
NF C32-070-2.1(C2)
IEC 60332-1/EN 50265-2-1



Low Corrosivity
EN 50267-2-2/NF C32-074
IEC 60754-2/NF C20-453



Low Toxicity



Low Smoke Emission
IEC 61034/NFC20-902
EN 50268/NF C32-073

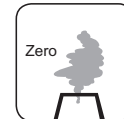

Zero Halogen
IEC 60754-1/NF C20-454
EN 50267-2-1



3GKW-RW/S 0.6/1KV Thin Wall Multicore

Applications

Multi core power and control cable designed for protected, fixed installation inside and outside railway vehicles for connecting fixed and moving parts in direct current and alternating voltage technology, especially converter technology.



Standard

- BS 6853 -1a
- DIN 5510-2 1-4
- NFF 16-101 F0

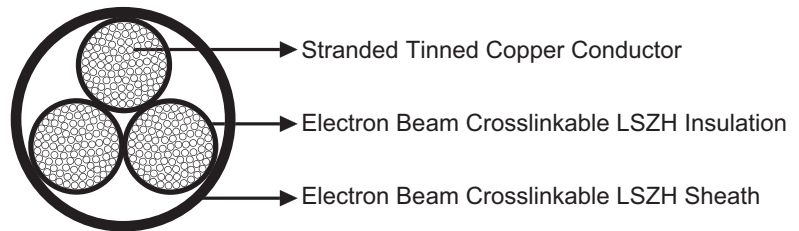

Construction

- **Conductors:** Circular Class 5 stranded tinned copper to IEC60228/VDE 0295.
- **Insulation:** Electron beam crosslinkable LSZH compound.
- **Sheath:** Electron beam crosslinkable LSZH compound.

Electrical Characteristics at 20°C

Nominal Conductor Cross Section	mm ²	0.5	0.75	1	1.5	2.5
Maximum Conductor Resistance	Ω/km	40.1	26.7	20.0	13.7	8.21
Voltage Rating	KV	0.6/1				

Mechanical and Thermal Properties

Minimum Bending Radius: 4xOD (Static); 6xOD (Flexing)
 Temperature Range: -60°C ~+120°C (Static); -40°C ~+90°C (Flexing)
 Short Circuit Temperature: +280°C



Dimensions and Weight

No. of cores & Nominal Conductor Cross Sectional Area No. × mm ²	Number and Nominal Diameter of Strands No/mm	Nominal Insulation Thickness mm	Nominal Overall Diameter mm	Nominal Weight kg/km
2×0.5	16/0.20	0.3	4.4	29
3×0.5	16/0.20	0.3	4.6	36
4×0.5	16/0.20	0.3	5.0	44
5×0.5	16/0.20	0.3	5.4	52
6×0.5	16/0.20	0.3	5.9	62
2×2×0.5	16/0.20	0.3	6.5	58
4×2×0.5	16/0.20	0.3	8.7	99
2×0.75	24/0.20	0.3	4.75	35
3×0.75	24/0.20	0.3	5.2	48
4×0.75	24/0.20	0.3	5.6	58
6×0.75	24/0.20	0.3	6.7	83
2×2×0.75	24/0.20	0.3	7.75	81
2×1.0	32/0.20	0.3	5.1	45
3×1.0	32/0.20	0.3	5.4	54
4×1.0	32/0.20	0.3	5.8	64
6×1.0	32/0.20	0.3	7.3	98
10×1.0	32/0.20	0.3	8.9	150
25×1.0	32/0.20	0.3	12.8	324
2×1.5	30/0.25	0.3	6.0	63
3×1.5	30/0.25	0.3	6.3	76
4×1.5	30/0.25	0.3	6.9	94
5×1.5	30/0.25	0.3	7.7	120
6×1.5	30/0.25	0.3	8.5	141
8×1.5	30/0.25	0.3	10.2	201
10×1.5	30/0.25	0.3	10.5	216
18×1.5	30/0.25	0.3	13.4	358
2×2.5	50/0.25	0.4	7.2	98
3×2.5	50/0.25	0.4	7.5	122
4×2.5	50/0.25	0.4	8.7	147
5×2.5	50/0.25	0.4	9.3	180
6×2.5	50/0.25	0.4	10.6	223



Impact Resistant



Highly Flexible

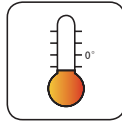

Cold Resistant

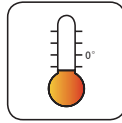

Soldering Heat Resistant

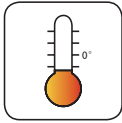

Low Temperature Resistant



Corona Resistant



Fire Retardant
NF C32-070-2.2(C1)
IEC 60332-3/EN50266



Flame Retardant
NF C32-070-2.1(C2)
IEC 60332-1/EN 50265-2-1



Low Corrosivity
EN 50267-2-2/NF C32-074
IEC 60754-2/NF C20-453



IRM 903 Fuel Oil Resistant



IRM 902 Mineral Oil Resistant

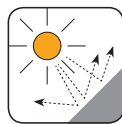

UV Resistant

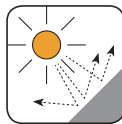

Ozone Resistant



Acid and Alkali Resistant

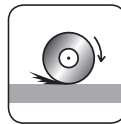

Abrasion Resistant



Low Smoke Emission
IEC 61034/NFC20-902
EN 50268/NF C32-073



Low Toxicity

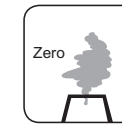

Zero Halogen
IEC 60754-1/NF C20-454
EN 50267-2-1





3GKW-RW/S EMC 0.6/1KV Thin Wall Screened Multicore

Applications

Multi core power and control cable designed for protected, fixed installation inside and outside railway vehicles for connecting fixed and moving parts in direct current and alternating voltage technology, especially converter technology.



Standard

- BS 6853 -1a
- DIN 5510-2 1-4
- NFF 16-101 F0

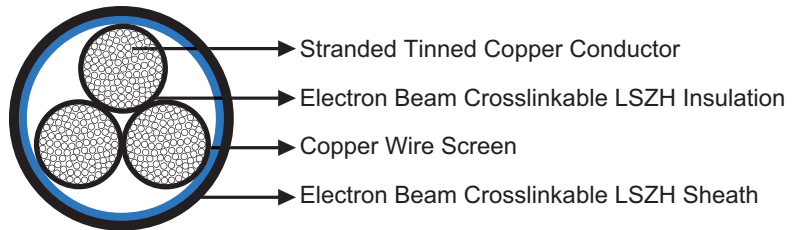

Construction

- **Conductors:** Circular Class 5 stranded tinned copper to IEC60228/VDE 0295.
- **Insulation:** Electron beam crosslinkable LSZH compound.
- **Screen:** Copper wire screen.
- **Sheath:** Electron beam crosslinkable LSZH compound.

Electrical Characteristics at 20°C

Nominal Conductor Cross Section	mm ²	0.5	0.75	1	1.5	2.5
Maximum Conductor Resistance	Ω/km	40.1	26.7	20.0	13.7	8.21
Voltage Rating	KV	0.6/1				

Mechanical and Thermal Properties

Minimum Bending Radius: 4xOD (Static); 8xOD (Flexing)
 Temperature Range: -60°C ~+120°C (Static); -40°C ~+90°C (Flexing)
 Short Circuit Temperature: +280°C



Dimensions and Weight

No. of cores & Nominal Conductor Cross Sectional Area No. × mm ²	Number and Nominal Diameter of Strands No/mm	Nominal Insulation Thickness mm	Nominal Overall Diameter mm	Nominal Weight kg/km
2×0.5	16/0.20	0.3	4.8	42
3×0.5	16/0.20	0.3	5.0	51
4×0.5	16/0.20	0.3	5.4	56
6×0.5	16/0.20	0.3	6.5	82
15×0.5	16/0.20	0.3	9.0	167
3×2×0.5	16/0.20	0.3	8.1	98
12×2×0.5	16/0.20	0.3	13.0	276
2×0.75	24/0.20	0.3	5.0	48
4×0.75	24/0.20	0.3	6.0	72
6×0.75	24/0.20	0.3	7.2	103
10×0.75	24/0.20	0.3	8.7	152
18×0.75	24/0.20	0.3	11.0	244
3×2×0.75	24/0.20	0.3	9.0	127
2×1.0	32/0.20	0.3	5.6	60
3×1.0	32/0.20	0.3	6.0	76
4×1.0	32/0.20	0.3	6.5	88
6×1.0	32/0.20	0.3	7.8	114
8×1.0	32/0.20	0.3	8.9	171
25×1.0	32/0.20	0.3	13.8	392
2×2×1.0	32/0.20	0.3	8.3	117
2×1.5	30/0.25	0.3	6.5	86
3×1.5	30/0.25	0.3	6.8	95
4×1.5	30/0.25	0.3	7.4	118
6×1.5	30/0.25	0.3	9.0	168
18×1.5	30/0.25	0.3	14.4	452
2×2.5	50/0.25	0.4	7.8	122
6×2.5	50/0.25	0.4	11.4	268



Impact Resistant



Highly Flexible

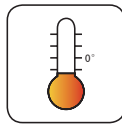

Cold Resistant

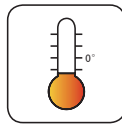

Soldering Heat Resistant

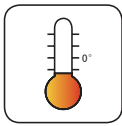

Low Temperature Resistant



Corona Resistant



Fire Retardant
NF C32-070-2.2(C1)
IEC 60332-3/EN50266



Flame Retardant
NF C32-070-2.1(C2)
IEC 60332-1/EN 50265-2-1



Low Corrosivity
EN 50267-2-2/NF C32-074
IEC 60754-2/NF C20-453



IRM 903 Fuel Oil Resistant



IRM 902 Mineral Oil Resistant

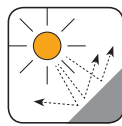

UV Resistant

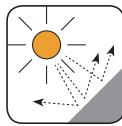

Ozone Resistant



Acid and Alkali Resistant

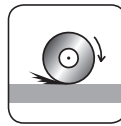

Abrasion Resistant



Low Smoke Emission
IEC 61034/NFC20-902
EN 50268/NF C32-073



Low Toxicity

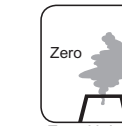

Zero Halogen
IEC 60754-1/NF C20-454
EN 50267-2-1





3GKW-SW 0.6/1KV Standard Wall Single Core

Applications

Single core power and control cable designed for protected, fixed installation inside and outside railway vehicles for connecting fixed and moving parts in direct current and alternating voltage technology, especially converter technology.



Standard

- BS 6853 -1a
- DIN 5510-2 1-4
- NFF 16-101 F0

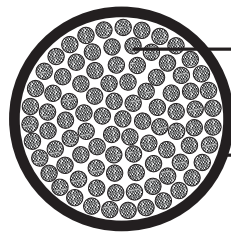

→ Stranded Tinned Copper Conductor

→ Electron Beam Crosslinkable LSZH Insulation

Construction

- **Conductors:** Circular Class 5 stranded tinned copper to IEC60228/VDE 0295.
- **Insulation:** Electron beam crosslinkable LSZH compound.

Electrical Characteristics at 20°C

Nominal Conductor Cross Section	mm ²	0.5	0.75	1	1.5	2.5	4.0	6.0	10	16	25	35
Maximum Conductor Resistance	Ω/km	40.1	26.7	20.0	13.7	8.21	5.09	3.39	1.95	1.24	0.795	0.565
Voltage Rating	KV	0.6/1										

Nominal Conductor Cross Section	mm ²	50	70	95	120	150	185	240	300	400
Maximum Conductor Resistance	Ω/km	0.393	0.277	0.21	0.164	0.132	0.108	0.0817	0.0654	0.0495
Voltage Rating	KV	0.6/1								

Mechanical and Thermal Properties

Minimum Bending Radius: 4xOD (Static); 6xOD (Flexing)
 Temperature Range: -40°C ~+120°C (Static); -35°C ~+90°C (Flexing)
 Short Circuit Temperature: +280°C



Dimensions and Weight

No. of cores & Nominal Conductor Cross Sectional Area No. x mm ²	Number and Nominal Diameter of Strands No/mm	Nominal Insulation Thickness mm	Nominal Overall Diameter mm	Nominal Weight kg/km
1x0.5	16/0.20	0.6	2.0	8
1x0.75	24/0.20	0.6	2.2	11
1x1.0	32/0.20	0.6	2.4	14
1x1.5	30/0.25	0.7	2.7	20
1x2.5	50/0.25	0.7	3.3	31
1x4	56/0.30	0.7	3.9	45
1x6	84/0.30	0.7	4.4	69
1x10	80/0.40	0.7	5.3	113
1x16	126/0.40	0.7	7.0	156
1x25	196/0.40	0.9	8.5	250
1x35	276/0.40	0.9	9.8	330
1x50	396/0.40	1.0	11.9	500
1x70	360/0.50	1.0	14.1	690
1x95	475/0.50	1.1	15.9	883
1x120	608/0.50	1.1	17.4	1180
1x150	756/0.50	1.4	20.3	1460
1x185	925/0.50	1.6	22.0	1780
1x240	1221/0.50	1.7	25.2	2220
1x300	1525/0.50	1.8	28.0	3000
1x400	2013/0.50	2.0	31.5	4000



Impact Resistant



Highly Flexible

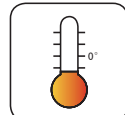

Cold Resistant

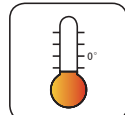

Soldering Heat Resistant

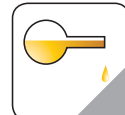

IRM 902 Mineral Oil Resistant

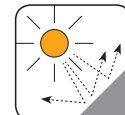

UV Resistant

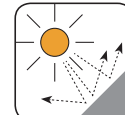

Ozone Resistant



Acid and Alkali Resistant



Fire Retardant
NF C32-070-2.2(C1)
IEC 60332-3/EN50266



Flame Retardant
NF C32-070-2.1(C2)
IEC 60332-1/EN 50265-2-1



Low Corrosivity
EN 50267-2-2/NF C32-074
IEC 60754-2/NF C20-453



Low Toxicity



Low Smoke Emission
IEC 61034/NFC20-902
EN 50268/NF C32-073

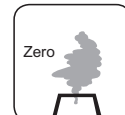

Zero Halogen
IEC 60754-1/NF C20-454
EN 50267-2-1



3GKW-SW/S 0.6/1KV Standard Wall Multicore

Applications

Multi core power and control cable designed for protected, fixed installation inside and outside railway vehicles for connecting fixed and moving parts in direct current and alternating voltage technology, especially converter technology.



Standard

- BS 6853 -1a
- DIN 5510-2 1-4
- NFF 16-101 F0

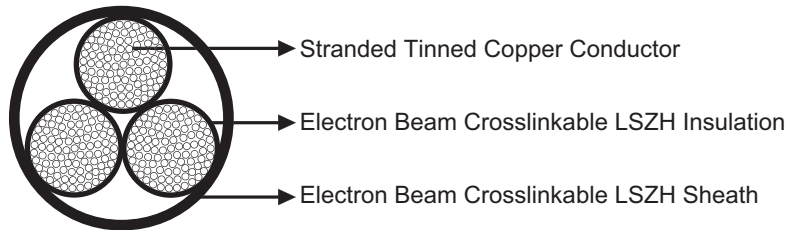

Construction

- **Conductors:** Circular Class 5 stranded tinned copper to IEC60228/VDE 0295.
- **Insulation:** Electron beam crosslinkable LSZH compound.
- **Sheath:** Electron beam crosslinkable LSZH compound.

Electrical Characteristics at 20°C

Nominal Conductor Cross Section	mm ²	0.5	0.75	1	1.5	2.5	4.0
Maximum Conductor Resistance	Ω/km	40.1	26.7	20.0	13.7	8.21	5.09
Voltage Rating	KV	0.6/1					

Mechanical and Thermal Properties

Minimum Bending Radius: 4xOD (Static); 6xOD (Flexing)
 Temperature Range: -60°C ~+120°C (Static); -40°C ~+90°C (Flexing)
 Short Circuit Temperature: +280°C



Dimensions and Weight

No. of cores& Nominal Conductor Cross Sectional Area No.×mm ²	Number and Nominal Diameter of Strands No/mm	Nominal Insulation Thickness mm	Nominal Overall Diameter mm	Nominal Weight kg/km
2×0.5	16/0.20	0.6	5.5	39
3×0.5	16/0.20	0.6	5.7	50
4×0.5	16/0.20	0.6	6.3	62
5×0.5	16/0.20	0.6	6.9	74
7×0.5	16/0.20	0.6	8.2	99
10×0.5	16/0.20	0.6	9.3	125
2×0.75	24/0.20	0.6	6.0	49
3×0.75	24/0.20	0.6	6.2	63
4×0.75	24/0.20	0.6	6.9	77
5×0.75	24/0.20	0.6	7.7	96
7×0.75	24/0.20	0.6	9.1	131
2×1.0	32/0.20	0.6	6.4	59
3×1.0	32/0.20	0.6	6.8	78
4×1.0	32/0.20	0.6	7.4	93
5×1.0	32/0.20	0.6	8.3	115
7×1.0	32/0.20	0.6	9.9	163
2×1.5	30/0.25	0.7	7.1	75
3×1.5	30/0.25	0.7	7.4	96
4×1.5	30/0.25	0.7	8.3	120
5×1.5	30/0.25	0.7	9.1	146
7×1.5	30/0.25	0.7	11.1	173
12×1.5	30/0.25	0.7	13.4	305
2×2.5	50/0.25	0.7	8.5	115
3×2.5	50/0.25	0.7	8.9	149
4×2.5	50/0.25	0.7	9.9	183
5×2.5	50/0.25	0.7	11.1	228
7×2.5	50/0.25	0.7	13.0	309
3×4	56/0.30	0.7	10.2	207
4×4	56/0.30	0.7	11.3	261
5×4	56/0.30	0.7	12.6	324



Impact Resistant



Highly Flexible

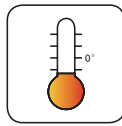

Cold Resistant

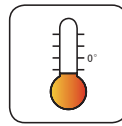

Soldering Heat Resistant

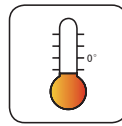

Low Temperature Resistant



Corona Resistant



Fire Retardant
NF C32-070-2.2(C1)
IEC 60332-3/EN50266



Flame Retardant
NF C32-070-2.1(C2)
IEC 60332-1/EN 50265-2-1



Low Corrosivity
EN 50267-2-2/NF C32-074
IEC 60754-2/NF C20-453



IRM 903 Fuel Oil Resistant



IRM 902 Mineral Oil Resistant

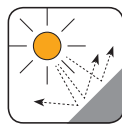

UV Resistant

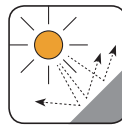

Ozone Resistant



Acid and Alkali Resistant

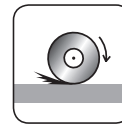

Abrasion Resistant



Low Smoke Emission
IEC 61034/NFC20-902
EN 50268/NF C32-073



Low Toxicity

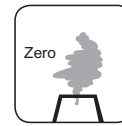

Zero Halogen
IEC 60754-1/NF C20-454
EN 50267-2-1





3GKW-SW/S EMC 0.6/1KV Standard Wall Screened Multicore

Applications

Multi core power and control cable designed for protected, fixed installation inside and outside railway vehicles for connecting fixed and moving parts in direct current and alternating voltage technology, especially converter technology.



Standard

- BS 6853 -1a
- DIN 5510-2 1-4
- NFF 16-101 F0

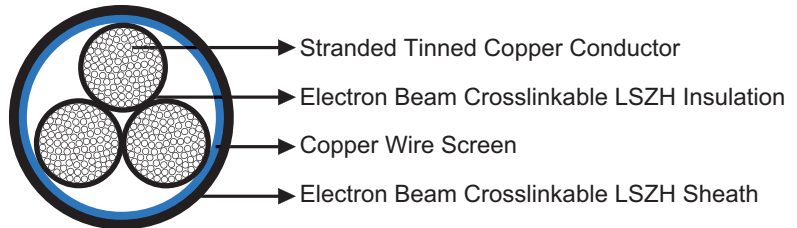

Construction

- **Conductors:** Circular Class 5 stranded tinned copper to IEC60228/VDE 0295.
- **Insulation:** Electron beam crosslinkable LSZH compound.
- **Screen:** Copper wire screen.
- **Sheath:** Electron beam crosslinkable LSZH compound.

Electrical Characteristics at 20°C

Nominal Conductor Cross Section	mm ²	1.5	2.5	4.0	10	16	25	35	50
Maximum Conductor Resistance	Ω/km	13.7	8.21	5.09	1.95	1.24	0.795	0.565	0.393
Voltage Rating	KV	0.6/1							

Mechanical and Thermal Properties

Minimum Bending Radius: 4xOD (Static); 8xOD (Flexing)
 Temperature Range: -60°C ~+120°C (Static); -40°C ~+90°C (Flexing)
 Short Circuit Temperature: +280°C



Dimensions and Weight

No. of cores& Nominal Conductor Cross Sectional Area No.×mm ²	Number and Nominal Diameter of Strands No/mm	Nominal Insulation Thickness mm	Nominal Overall Diameter mm	Nominal Weight kg/km
2×0.5	16/0.2	0.6	6.6	68
4×0.5	16/0.2	0.6	7.5	102
7×0.5	16/0.2	0.6	9.8	150
15×0.5	16/0.2	0.6	13.2	240
9×2×0.5	24/0.20	0.6	20.6	540
3×0.75	24/0.20	0.6	7.5	90
6×0.75	24/0.20	0.6	9.9	165
9×0.75	24/0.20	0.6	12.3	245
16×0.75	24/0.20	0.6	14.3	348
5×2×0.75	24/0.20	0.6	16.2	350
4×1.0	32/0.20	0.6	8.8	140
7×1.0	32/0.20	0.6	11.6	226
3×1.5	32/0.25	0.7	8.6	124
5×1.5	32/0.25	0.7	10.9	208
9×1.5	30/0.25	0.7	14.9	409
16×1.5	30/0.25	0.7	17.5	560
6×2×1.5	30/0.25	0.7	18.8	540
2×2.5	50/0.25	0.7	9.6	160
4×2.5	50/0.25	0.7	11.3	220
7×2.5	50/0.25	0.7	14.8	400
3×4	56/0.30	0.7	11.8	260
5×4	56/0.30	0.7	14.7	440
3×6	84/0.30	0.7	13.5	370
5×6	84/0.30	0.7	17.4	620
3×10	80/0.40	0.7	17.1	580
4×10	80/0.40	0.7	19.2	750
5×10	80/0.40	0.7	21.0	850
3×16	126/0.40	0.7	20.5	820
2×25	196/0.40	0.9	22.5	990
3×35	276/0.40	0.9	27.9	1600
6×35	276/0.40	0.9	39.7	3350
2×50	396/0.40	1.0	29.5	1760



Impact Resistant



Highly Flexible



Cold Resistant

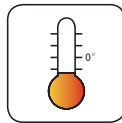

Soldering Heat Resistant



Low Temperature Resistant



Corona Resistant



Fire Retardant
NF C32-070-2.2(C1)
IEC 60332-3/EN50266



Flame Retardant
NF C32-070-2.1(C2)
IEC 60332-1/EN 50265-2-1



Low Corrosivity
EN 50267-2-2/NF C32-074
IEC 60754-2/NF C20-453



IRM 903 Fuel Oil Resistant



IRM 902 Mineral Oil Resistant

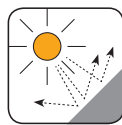

UV Resistant

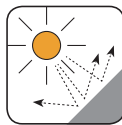

Ozone Resistant



Acid and Alkali Resistant

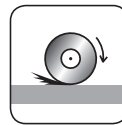

Abrasion Resistant



Low Smoke Emission
IEC 61034/NFC20-902
EN 50268/NF C32-073



Low Toxicity

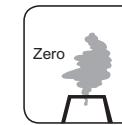

Zero Halogen
IEC 60754-1/NF C20-454
EN 50267-2-1





3GKW-DW 0.6/1KV Dual Wall Single Core

Applications

Single core power and control cable designed for protected, fixed installation inside and outside railway vehicles for connecting fixed and moving parts in direct current and alternating voltage technology, especially converter technology.



Standard

- BS 6853 -1a
- DIN 5510-2 1-4
- NFF 16-101 F0

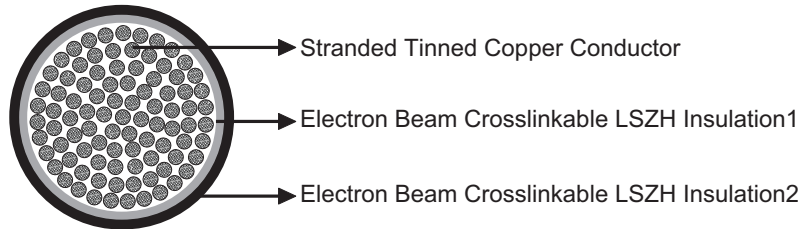

Construction

- **Conductors:** Circular Class 5 stranded tinned copper to IEC60228/VDE 0295.
- **Insulation1:** Electron beam crosslinkable LSZH compound.
- **Insulation2:** Electron beam crosslinkable LSZH compound.

Electrical Characteristics at 20°C

Nominal Conductor Cross Section	mm ²	0.5	0.6	0.75	1	1.2	1.5	2.0	2.5	3	4.0
AWG			20		18	16		14		12	
Maximum Conductor Resistance	Ω/km	40.1	31.1	26.7	20.0	15.5	13.7	10.5	8.21	6.56	5.09
Voltage Rating	KV	0.6/1									

Mechanical and Thermal Properties

Minimum Bending Radius: 4xOD (Static); 6xOD (Flexing)
 Temperature Range: -60°C ~+120°C (Static); -40°C ~+90°C (Flexing)
 Short Circuit Temperature: +280°C



Dimensions and Weight

No. of cores & Nominal Conductor Cross Sectional Area No. x mm ²	Number and Nominal Diameter of Strands No/mm	Nominal Insulation Thickness mm	Nominal Overall Diameter mm	Nominal Weight kg/km
1x0.5	16/0.20	0.2	1.32	5.5
1x0.6	19/0.20	0.2	1.40	6.5
1x0.75	24/0.20	0.2	1.52	8
1x1.0	32/0.20	0.2	1.65	10
1x1.2	19/0.28	0.2	1.83	12
1x1.5	30/0.25	0.3	2.04	15
1x2.0	37/0.25	0.3	2.29	19
1x2.5	50/0.25	0.3	2.60	24
1x3	37/0.32	0.3	2.70	29
1x4	56/0.30	0.4	3.21	39



Impact Resistant



Highly Flexible

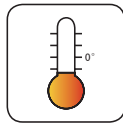

Cold Resistant



Soldering Heat Resistant



Low Temperature Resistant



Corona Resistant



Fire Retardant
NF C32-070-2.2(C1)
IEC 60332-3/EN50266



Flame Retardant
NF C32-070-2.1(C2)
IEC 60332-1/EN 50265-2-1



Low Corrosivity
EN 50267-2-2/NF C32-074
IEC 60754-2/NF C20-453



IRM 903 Fuel Oil Resistant



IRM 902 Mineral Oil Resistant

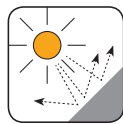

UV Resistant

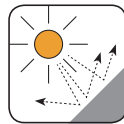

Ozone Resistant



Acid and Alkali Resistant

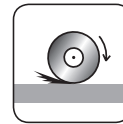

Abrasion Resistant



Low Smoke Emission
IEC 61034/NFC20-902
EN 50268/NF C32-073



Low Toxicity

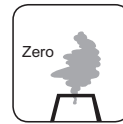

Zero Halogen
IEC 60754-1/NF C20-454
EN 50267-2-1



3GKW-DW/S 0.6/1KV Dual Wall Multicore

Applications

Multi core power and control cable designed for protected, fixed installation inside and outside railway vehicles for connecting fixed and moving parts in direct current and alternating voltage technology, especially converter technology.



Standard

- BS 6853 -1a
- DIN 5510-2 1-4
- NFF 16-101 F0

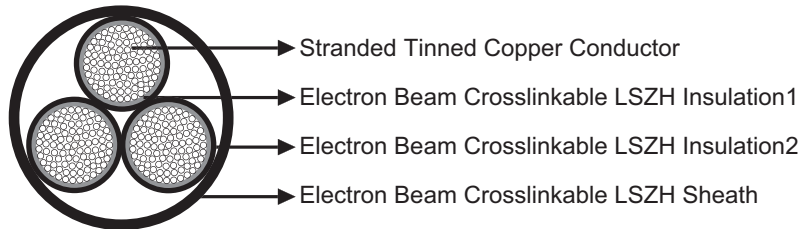

Construction

- **Conductors:** Circular Class 5 stranded tinned copper to IEC60228/VDE 0295.
- **Insulation1:** Electron beam crosslinkable LSZH compound.
- **Insulation2:** Electron beam crosslinkable LSZH compound.
- **Sheath:** Electron beam crosslinkable LSZH compound.

Electrical Characteristics at 20°C

Nominal Conductor Cross Section	mm ²	0.5	0.75	1	1.5	2.5
Maximum Conductor Resistance	Ω/km	40.1	26.7	20.0	13.7	8.21
Voltage Rating	KV	0.6/1				

Mechanical and Thermal Properties

Minimum Bending Radius: 4xOD (Static); 6xOD (Flexing)
 Temperature Range: -60°C ~+120°C (Static); -40°C ~+90°C (Flexing)
 Short Circuit Temperature: +280°C



Dimensions and Weight

No. of cores & Nominal Conductor Cross Sectional Area No. x mm ²	Number and Nominal Diameter of Strands No./mm	Nominal Insulation Thickness mm	Nominal Overall Diameter mm	Nominal Weight kg/km
2x0.5	16/0.20	0.2	4.1	24
3x0.5	16/0.20	0.2	4.6	36
5x0.5	16/0.20	0.2	5.0	43
9x0.5	16/0.20	0.2	6.6	64
12x0.5	16/0.20	0.2	6.9	89
16x0.5	16/0.20	0.2	7.8	115
25x0.5	16/0.20	0.2	9.5	170
30x0.5	16/0.20	0.2	10.0	204
2x2x0.5	16/0.20	0.2	5.8	50
2x0.75	24/0.20	0.2	4.4	32
4x0.75	24/0.20	0.2	5.0	49
9x0.75	24/0.20	0.2	7.7	106
14x0.75	24/0.20	0.2	8.4	140
27x0.75	24/0.20	0.2	11.1	268
36x0.75	24/0.20	0.2	12.8	360
3x1.0	32/0.20	0.2	5.0	45
6x1.0	32/0.20	0.2	6.6	88
14x1.0	32/0.20	0.2	9.1	174
20x1.0	32/0.20	0.2	11.2	255
50x1.0	32/0.20	0.2	16.6	620
2x1.5	30/0.25	0.3	5.4	55
5x1.5	30/0.25	0.3	7.1	110
7x1.5	30/0.25	0.3	8.2	150
10x1.5	30/0.25	0.3	9.9	170
18x1.5	30/0.25	0.3	12.4	350
30x1.5	30/0.25	0.3	15.6	560
50x1.5	30/0.25	0.3	20.0	868
3x2.5	50/0.25	0.3	7.0	105
6x2.5	50/0.25	0.3	9.4	200
12x2.5	50/0.25	0.3	12.6	360
18x2.5	50/0.25	0.3	15.3	545
24x2.5	50/0.25	0.3	17.8	695
30x2.5	50/0.25	0.3	19.1	870
36x2.5	50/0.25	0.3	21.0	1050



Impact Resistant



Highly Flexible

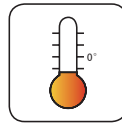

Cold Resistant

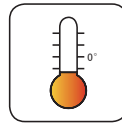

Soldering Heat Resistant

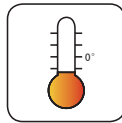

Low Temperature Resistant



Corona Resistant



Fire Retardant
NF C32-070-2.2(C1)
IEC 60332-3/EN50266



Flame Retardant
NF C32-070-2.1(C2)
IEC 60332-1/EN 50265-2-1



Low Corrosivity
EN 50267-2-2/NF C32-074
IEC 60754-2/NF C20-453



IRM 903 Fuel Oil Resistant



IRM 902 Mineral Oil Resistant

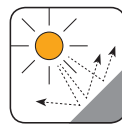

UV Resistant

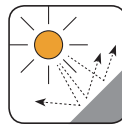

Ozone Resistant



Acid and Alkali Resistant

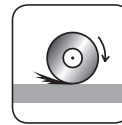

Abrasion Resistant



Low Smoke Emission
IEC 61034/NFC20-902
EN 50268/NF C32-073



Low Toxicity

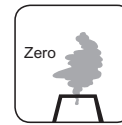

Zero Halogen
IEC 60754-1/NF C20-454
EN 50267-2-1





3GKW-DW/S EMC 0.6/1KV Dual Wall Screened Multicore

Applications

Multi core power and control cable designed for protected, fixed installation inside and outside railway vehicles for connecting fixed and moving parts in direct current and alternating voltage technology, especially converter technology.



Standard

- BS 6853 -1a
- DIN 5510-2 1-4
- NFF 16-101 F0

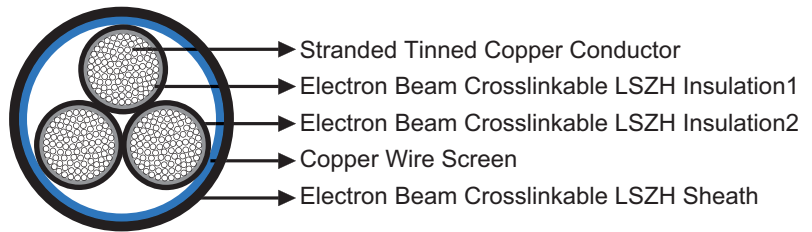

Construction

- **Conductors:** Circular Class 5 stranded tinned copper to IEC60228/VDE 0295.
- **Insulation1:** Electron beam crosslinkable LSZH compound.
- **Insulation2:** Electron beam crosslinkable LSZH compound.
- **Screen:** Copper wire screen.
- **Sheath:** Electron beam crosslinkable LSZH compound.

Electrical Characteristics at 20°C

Nominal Conductor Cross Section	mm ²	0.25	0.5	0.75	1	1.5	2.5
Maximum Conductor Resistance	Ω/km	88.5	40.1	26.7	20.0	13.7	8.21
Voltage Rating	KV	0.6/1					

Mechanical and Thermal Properties

Minimum Bending Radius: 4xOD (Static); 8xOD (Flexing)
 Temperature Range: -60°C ~+120°C (Static); -40°C ~+90°C (Flexing)
 Short Circuit Temperature: +280°C



▾ Dimensions and Weight

No. of cores& Nominal Conductor Cross Sectional Area No.×mm ²	Number and Nominal Diameter of Strands No/mm	Nominal Insulation Thickness mm	Nominal Overall Diameter mm	Nominal Weight kg/km
2×2×0.25	19/0.13	0.2	5.7	48
3×2×0.25	19/0.13	0.2	6.1	57
4×2×0.25	19/0.13	0.2	7.0	72
7×2×0.25	19/0.13	0.2	7.8	92
25×0.25	19/0.13	0.2	8.9	139
2×0.5	16/0.20	0.2	4.3	34
3×0.5	16/0.20	0.2	4.5	40
4×0.5	16/0.20	0.2	4.8	47
5×0.5	16/0.20	0.2	5.4	58
6×0.5	16/0.20	0.2	5.9	70
7×0.5	16/0.20	0.2	6.3	80
8×0.5	16/0.20	0.2	6.8	86
9×0.5	16/0.20	0.2	7.2	95
10×0.5	16/0.20	0.2	7.2	101
12×0.5	16/0.20	0.2	7.4	110
15×0.5	16/0.20	0.2	8.3	135
16×0.5	16/0.20	0.2	8.5	142
18×0.5	16/0.20	0.2	8.9	162
20×0.5	16/0.20	0.2	9.3	183
22×0.5	16/0.20	0.2	9.9	195
25×0.5	16/0.20	0.2	10.3	213
27×0.5	16/0.20	0.2	10.5	231
30×0.5	16/0.20	0.2	11.3	265
36×0.5	16/0.20	0.2	12.1	301
42×0.5	16/0.20	0.2	12.9	359
48×0.5	16/0.20	0.2	13.6	410
50×0.5	16/0.20	0.2	14.2	430
2×2×0.5	16/0.20	0.2	6.4	69
3×2×0.5	16/0.20	0.2	6.7	80
4×2×0.5	16/0.20	0.2	7.4	95
5×2×0.5	16/0.20	0.2	9.1	136
6×2×0.5	16/0.20	0.2	9.2	148
8×2×0.5	16/0.20	0.2	9.7	155
10×2×0.5	16/0.20	0.2	10.9	200
12×2×0.5	16/0.20	0.2	12.1	239
15×2×0.5	16/0.20	0.2	13.0	300
16×2×0.5	16/0.20	0.2	13.2	320
20×2×0.5	16/0.20	0.2	14.4	360
2×3×0.5	16/0.20	0.2	7.3	90
2×0.75	24/0.20	0.2	4.8	40
3×0.75	24/0.20	0.2	5.0	50
4×0.75	24/0.20	0.2	5.5	62
5×0.75	24/0.20	0.2	6.1	75



No. of cores& Nominal Conductor Cross Sectional Area No.×mm ²	Number and Nominal Diameter of Strands No./mm	Nominal Insulation Thickness mm	Nominal Overall Diameter mm	Nominal Weight kg/km
6×0.75	24/0.20	0.2	6.6	85
7×0.75	24/0.20	0.2	7.2	100
8×0.75	24/0.20	0.2	7.7	113
10×0.75	24/0.20	0.2	8.1	130
12×0.75	24/0.20	0.2	8.4	150
14×0.75	24/0.20	0.2	9.1	169
16×0.75	24/0.20	0.2	9.7	206
18×0.75	24/0.20	0.2	10.1	230
20×0.75	24/0.20	0.2	11.1	256
24×0.75	24/0.20	0.2	12.0	294
25×0.75	24/0.20	0.2	12.3	300
2×2×0.75	24/0.20	0.2	7.1	85
3×2×0.75	24/0.20	0.2	7.6	109
4×2×0.75	24/0.20	0.2	9.9	143
5×2×0.75	24/0.20	0.2	10.7	182
6×2×0.75	24/0.20	0.2	11.9	226
7×2×0.75	24/0.20	0.2	13.2	279
8×2×0.75	24/0.20	0.2	13.4	291
10×2×0.75	24/0.20	0.2	14.8	333
3×3×0.75	24/0.20	0.2	8.9	151
5×4×0.75	24/0.20	0.2	12.8	288
2×1.0	32/0.20	0.2	5.0	50
3×1.0	32/0.20	0.2	5.5	60
4×1.0	32/0.20	0.2	5.8	72
5×1.0	32/0.20	0.2	6.6	88
6×1.0	32/0.20	0.2	7.3	114
7×1.0	32/0.20	0.2	7.9	133
8×1.0	32/0.20	0.2	8.5	150
9×1.0	32/0.20	0.2	8.7	160
10×1.0	32/0.20	0.2	8.9	168
12×1.0	32/0.20	0.2	9.2	188
16×1.0	32/0.20	0.2	10.5	250
18×1.0	32/0.20	0.2	11.2	275
25×1.0	32/0.20	0.2	12.7	355
27×1.0	32/0.20	0.2	13.3	395
30×1.0	32/0.20	0.2	13.8	450
36×1.0	32/0.20	0.2	15.1	530
42×1.0	32/0.20	0.2	16.3	604
50×1.0	32/0.20	0.2	17.8	690
2×2×1.0	32/0.20	0.2	7.8	107
4×2×1.0	32/0.20	0.2	9.4	128
6×2×1.0	32/0.20	0.2	11.6	239
12×2×1.0	32/0.20	0.2	14.3	400
4×3×1.0	32/0.20	0.2	11.5	230
3×4×1.0	32/0.20	0.2	11.3	245



No. of cores& Nominal Conductor Cross Sectional Area No.×mm ²	Number and Nominal Diameter of Strands No/mm	Nominal Insulation Thickness mm	Nominal Overall Diameter mm	Nominal Weight kg/km
4×4×1.0	32/0.20	0.2	12.5	265
2×1.5	30/0.25	0.3	5.8	70
3×1.5	30/0.25	0.3	6.1	81
4×1.5	30/0.25	0.3	6.7	100
5×1.5	30/0.25	0.3	7.7	134
6×1.5	30/0.25	0.3	8.3	153
7×1.5	30/0.25	0.3	9.1	184
8×1.5	30/0.25	0.3	10.3	222
9×1.5	30/0.25	0.3	10.4	234
10×1.5	30/0.25	0.3	10.5	240
12×1.5	30/0.25	0.3	10.9	268
16×1.5	30/0.25	0.3	12.5	364
18×1.5	30/0.25	0.3	13.2	405
25×1.5	30/0.25	0.3	15.8	562
48×1.5	30/0.25	0.3	20.7	988
2×2×1.5	30/0.25	0.3	9.2	153
3×2×1.5	30/0.25	0.3	9.8	205
7×2×1.5	30/0.25	0.3	12.6	330
2×2.5	50/0.25	0.3	7.0	105
3×2.5	50/0.25	0.3	7.6	130
4×2.5	50/0.25	0.3	8.4	170
5×2.5	50/0.25	0.3	9.4	190
6×2.5	50/0.25	0.3	10.3	225
7×2.5	50/0.25	0.3	11.4	270
8×2.5	50/0.25	0.3	12.6	343
10×2.5	50/0.25	0.3	13.2	370
12×2.5	50/0.25	0.3	13.6	420
16×2.5	50/0.25	0.3	15.6	560
18×2.5	50/0.25	0.3	16.6	620
25×2.5	50/0.25	0.3	19.3	834
27×2.5	50/0.25	0.3	20.5	870
48×2.5	50/0.25	0.3	25.6	1560



Impact Resistant



Highly Flexible

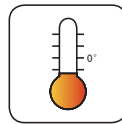

Cold Resistant

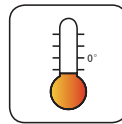

Soldering Heat Resistant

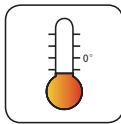

Low Temperature Resistant



Corona Resistant



Fire Retardant
NF C32-070-2.2(C1)
IEC 60332-3/EN50266



Flame Retardant
NF C32-070-2.1(C2)
IEC 60332-1/EN 50265-2-1



Low Corrosivity
EN 50267-2-2/NF C32-074
IEC 60754-2/NF C20-453



IRM 903 Fuel Oil Resistant



IRM 902 Mineral Oil Resistant

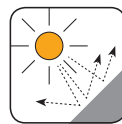

UV Resistant

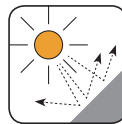

Ozone Resistant



Acid and Alkali Resistant

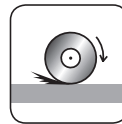

Abrasion Resistant



Low Smoke Emission
IEC 61034/NFC20-902
EN 50268/NF C32-073



Low Toxicity

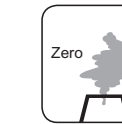

Zero Halogen
IEC 60754-1/NF C20-454
EN 50267-2-1





4GKW-AXplus-DW 1.8/3KV Dual Wall Single Core

Applications

Single core power and control cable designed for protected, fixed installation inside and outside railway vehicles for connecting fixed and moving parts in direct current and alternating voltage technology, especially converter technology.



Standard

- BS 6853 -1a
- DIN 5510-2 1-4
- NFF 16-101 F0

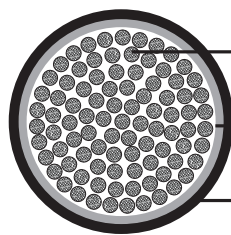

- Stranded Tinned Copper Conductor
- Electron Beam Crosslinkable LSZH Insulation1
- Electron Beam Crosslinkable LSZH Insulation2

Construction

- **Conductors:** Circular Class 5 stranded tinned copper to IEC60228/VDE 0295.
- **Insulation1:** Electron beam crosslinkable LSZH compound.
- **Insulation2:** Electron beam crosslinkable LSZH compound.

Electrical Characteristics at 20°C

Nominal Conductor Cross Section	mm ²	1.0	1.5	2.5	4.0	6.0	10	16	25	35	50
Maximum Conductor Resistance	Ω/km	20.0	13.7	8.21	5.09	3.39	1.95	1.24	0.795	0.565	0.393
Voltage Rating	KV	1.8/3.0									

Nominal Conductor Cross Section	mm ²	70	95	120	150	185	240	300	400
Maximum Conductor Resistance	Ω/km	0.277	0.21	0.164	0.132	0.108	0.0817	0.0654	0.0495
Voltage Rating	KV	1.8/3.0							

Mechanical and Thermal Properties

Minimum Bending Radius: 4xOD (Static); 6xOD (Flexing)
 Temperature Range: -60°C ~+120°C (Static); -40°C ~+90°C (Flexing)
 Short Circuit Temperature: +280°C



Dimensions and Weight

No. of cores & Nominal Conductor Cross Sectional Area No. x mm ²	Number and Nominal Diameter of Strands No/mm	Nominal Insulation Thickness mm	Nominal Overall Diameter mm	Nominal Weight kg/km
1x1.0	32/0.20	0.7	2.8	17
1x1.5	30/0.25	0.8	3.2	23
1x2.0	32/0.20	0.9	3.55	28
1x2.5	50/0.25	0.9	3.70	34
1x4.0	56/0.30	1.0	4.45	53
1x6.0	84/0.30	1.1	5.05	74
1x10	80/0.40	1.2	6.35	118
1x16	126/0.40	1.5	8.3	180
1x25	196/0.40	1.8	10.2	274
1x35	276/0.40	2.0	11.4	379
1x50	396/0.40	2.2	13.6	550
1x70	360/0.50	2.1	15.6	730
1x95	475/0.50	2.3	17.3	940
1x120	608/0.50	2.4	19.6	1180
1x150	756/0.50	2.6	21.9	1510
1x185	925/0.50	2.8	23.8	1802
1x240	1221/0.50	2.9	26.8	2290
1x300	1525/0.50	3.0	29.7	2928
1x400	2013/0.50	3.4	35.8	4040



Impact Resistant



Highly Flexible



Cold Resistant

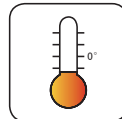

Soldering Heat Resistant

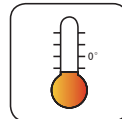

Low Temperature Resistant



Corona Resistant



Fire Retardant
NF C32-070-2.2(C1)
IEC 60332-3/EN50266



Flame Retardant
NF C32-070-2.1(C2)
IEC 60332-1/EN 50265-2-1



Low Corrosivity
EN 50267-2-2/NF C32-074
IEC 60754-2/NF C20-453



IRM 903 Fuel Oil Resistant



IRM 902 Mineral Oil Resistant

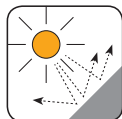

UV Resistant

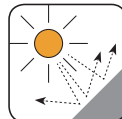

Ozone Resistant



Acid and Alkali Resistant

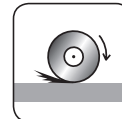

Abrasion Resistant



Low Smoke Emission
IEC 61034/NFC20-902
EN 50268/NF C32-073



Low Toxicity



Zero Halogen
IEC 60754-1/NF C20-454
EN 50267-2-1



4GKW-AXplus-DW EMC 1.8/3KV Dual Wall Screened Single Core

Applications

Single core power and control cable designed for protected, fixed installation inside and outside railway vehicles for connecting fixed and moving parts in direct current and alternating voltage technology, especially converter technology.



Standard

- BS 6853 -1a
- DIN 5510-2 1-4
- NFF 16-101 F0

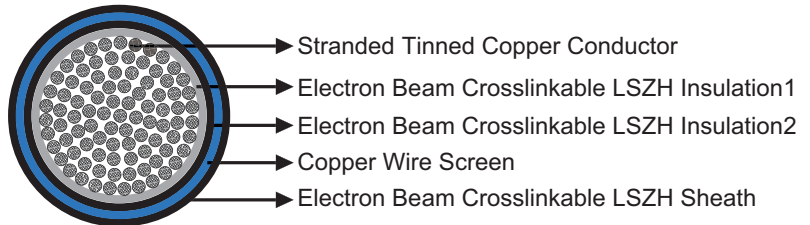

Construction

- **Conductors:** Circular Class 5 stranded tinned copper to IEC60228/VDE 0295.
- **Insulation1:** Electron beam crosslinkable LSZH compound.
- **Insulation2:** Electron beam crosslinkable LSZH compound.
- **Screen:** Copper wire screen.
- **Sheath:** Electron beam crosslinkable LSZH compound.

Electrical Characteristics at 20°C

Nominal Conductor Cross Section	mm ²	1.5	2.5	4.0	6.0	10	16	25	35	50
Maximum Conductor Resistance	Ω/km	13.7	8.21	5.09	3.39	1.95	1.24	0.795	0.565	0.393
Voltage Rating	KV	1.8/3								

Nominal Conductor Cross Section	mm ²	70	95	120	150	185	240	300	400
Maximum Conductor Resistance	Ω/km	0.277	0.21	0.164	0.132	0.108	0.0817	0.0654	0.0495
Voltage Rating	KV	1.8/3							



▾ Mechanical and Thermal Properties

Minimum Bending Radius: 4xOD (Static); 8xOD (Flexing)

Temperature Range: -60°C ~+120°C (Static); -40°C ~+90°C (Flexing)

Short Circuit Temperature: +280°C

▾ Dimensions and Weight

No. of cores& Nominal Conductor Cross Sectional Area No.×mm ²	Number and Nominal Diameter of Strands No/mm	Nominal Insulation Thickness mm	Nominal Overall Diameter mm	Nominal Weight kg/km
1×1.0	32/0.20	0.7	4.60	38
1×1.5	30/0.25	0.8	5.20	47
1×2.5	50/0.25	0.9	5.50	63
1×4	56/0.30	1.0	6.70	89
1×6	84/0.30	1.1	7.30	123
1×10	80/0.40	1.2	9.00	178
1×16	126/0.40	1.5	11.2	280
1×25	196/0.40	1.8	12.5	371
1×35	276/0.40	2.0	14.0	492
1×50	396/0.40	2.2	16.7	693
1×70	360/0.50	2.1	18.6	913
1×95	475/0.50	2.3	20.3	1160
1×120	608/0.50	2.4	23.4	1441
1×150	756/0.50	2.6	25.1	1730
1×185	925/0.50	2.8	27.8	2088
1×240	1221/0.50	2.9	30.2	2908
1×300	1525/0.50	3.0	34.2	3375
1×400	2013/0.50	3.4	37.1	4250



Impact Resistant



Highly Flexible



Cold Resistant

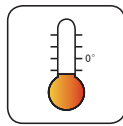

Soldering Heat Resistant

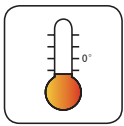

Low Temperature Resistant



Corona Resistant



Fire Retardant
NF C32-070-2.2(C1)
IEC 60332-3/EN50266



Flame Retardant
NF C32-070-2.1(C2)
IEC 60332-1/EN 50265-2-1



Low Corrosivity
EN 50267-2-2/NF C32-074
IEC 60754-2/NF C20-453



IRM 903 Fuel Oil Resistant



IRM 902 Mineral Oil Resistant

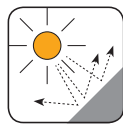

UV Resistant

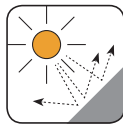

Ozone Resistant



Acid and Alkali Resistant

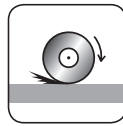

Abrasion Resistant



Low Smoke Emission
IEC 61034/NFC20-902
EN 50268/NF C32-073



Low Toxicity

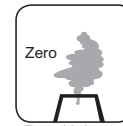

Zero Halogen
IEC 60754-1/NF C20-454
EN 50267-2-1



4GKW-AXplus-DW/S EMC 1.8/3KV Dual Wall Screened Multicore

Applications

Multi core power and control cable designed for protected, fixed installation inside and outside railway vehicles for connecting fixed and moving parts in direct current and alternating voltage technology, especially converter technology.



Standard

- BS 6853 -1a
- DIN 5510-2 1-4
- NFF 16-101 F0

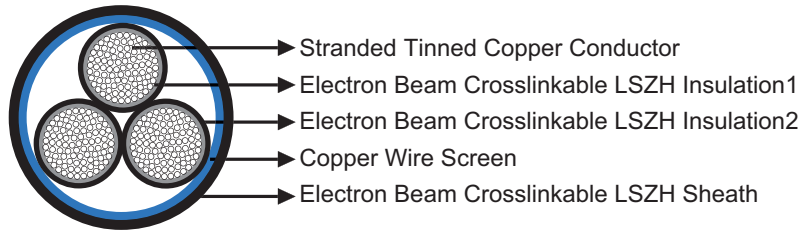

Construction

- **Conductors:** Circular Class 5 stranded tinned copper to IEC60228/VDE 0295.
- **Insulation1:** Electron beam crosslinkable LSZH compound.
- **Insulation2:** Electron beam crosslinkable LSZH compound.
- **Screen:** Copper wire screen.
- **Sheath:** Electron beam crosslinkable LSZH compound.

Electrical Characteristics at 20°C

Nominal Conductor Cross Section	mm ²	1.5	2.5	4.0	10	16	25	35
Maximum Conductor Resistance	Ω/km	13.7	8.21	5.09	1.95	1.24	0.795	0.565
Voltage Rating	KV	1.8/3						

Mechanical and Thermal Properties

Minimum Bending Radius: 4xOD (Static); 8xOD (Flexing)
 Temperature Range: -60°C ~+120°C (Static); -40°C ~+90°C (Flexing)
 Short Circuit Temperature: +280°C



Dimensions and Weight

No. of cores& Nominal Conductor Cross Sectional Area No.×mm ²	Number and Nominal Diameter of Strands No/mm	Nominal Insulation Thickness mm	Nominal Overall Diameter mm	Nominal Weight kg/km
2×1.5	30/0.25	0.8	9.2	135
3×1.5	30/0.25	0.8	10.0	164
6×1.5	30/0.25	0.8	13.7	315
3×2.5	30/0.25	0.9	11.4	225
4×4	56/0.30	1.0	15.3	427
3×10	80/0.40	1.2	18.2	648
3×16	126/0.40	1.5	23.1	900
3×25	196/0.40	1.8	28.4	1520
4×25	196/0.40	1.8	34.0	1869
2×35	276/0.40	2.0	29.7	1580
3×35	276/0.40	2.0	31.6	1970
4×35	276/0.40	2.0	37.0	2102



Impact Resistant



Highly Flexible

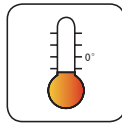

Cold Resistant

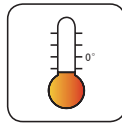

Soldering Heat Resistant



Low Temperature Resistant



Corona Resistant



Fire Retardant
NF C32-070-2.2(C1)
IEC 60332-3/EN50266



Flame Retardant
NF C32-070-2.1(C2)
IEC 60332-1/EN 50265-2-1



Low Corrosivity
EN 50267-2-2/NF C32-074
IEC 60754-2/NF C20-453



IRM 903 Fuel Oil Resistant



IRM 902 Mineral Oil Resistant

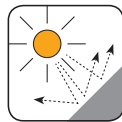

UV Resistant

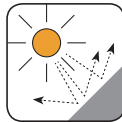

Ozone Resistant



Acid and Alkali Resistant

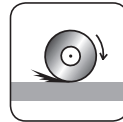

Abrasion Resistant



Low Smoke Emission
IEC 61034/NFC20-902
EN 50268/NF C32-073



Low Toxicity

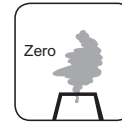

Zero Halogen
IEC 60754-1/NF C20-454
EN 50267-2-1



9GKW-AXplus-DW 3.6/6KV Dual Wall Single Core

Applications

Single core power and control cable designed for protected, fixed installation inside and outside railway vehicles for connecting fixed and moving parts in direct current and alternating voltage technology, especially converter technology.



Standard

- BS 6853 -1a
- DIN 5510-2 1-4
- NFF 16-101 F0

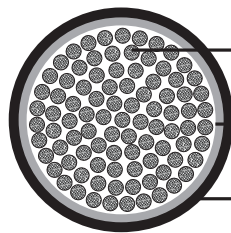

Stranded Tinned Copper Conductor

Electron Beam Crosslinkable LSZH Insulation1

Electron Beam Crosslinkable LSZH Insulation2

Construction

- **Conductors:** Circular Class 5 stranded tinned copper to IEC60228/VDE 0295.
- **Insulation1:** Electron beam crosslinkable LSZH compound.
- **Insulation2:** Electron beam crosslinkable LSZH compound.

Electrical Characteristics at 20°C

Nominal Conductor Cross Section	mm ²	1.5	2.5	4.0	6.0	10	16	25	35	50
Maximum Conductor Resistance	Ω/km	13.7	8.21	5.09	3.39	1.95	1.24	0.795	0.565	0.393
Voltage Rating	KV	3.6/6								

Nominal Conductor Cross Section	mm ²	70	95	120	150	185	240	300	400
Maximum Conductor Resistance	Ω/km	0.277	0.21	0.164	0.132	0.108	0.0817	0.0654	0.0495
Voltage Rating	KV	3.6/6							

Mechanical and Thermal Properties

Minimum Bending Radius: 4xOD (Static); 6xOD (Flexing)

Temperature Range: -60°C ~+120°C (Static); -40°C ~+90°C (Flexing)

Short Circuit Temperature: +280°C



Dimensions and Weight

No. of cores & Nominal Conductor Cross Sectional Area No. × mm ²	Number and Nominal Diameter of Strands No/mm	Nominal Insulation Thickness mm	Nominal Overall Diameter mm	Nominal Weight kg/km
1×1.5	30/0.25	1.4	4.4	34
1×2.5	50/0.25	1.5	4.9	47
1×4	56/0.30	1.6	5.7	68
1×6	84/0.30	1.7	6.3	88
1×10	80/0.40	1.8	7.5	140
1×16	126/0.40	2.1	9.4	205
1×25	196/0.40	2.2	10.9	297
1×35	276/0.40	2.4	12.2	410
1×50	396/0.40	2.6	14.5	570
1×70	360/0.50	2.6	16.5	760
1×95	475/0.50	2.9	18.5	980
1×120	608/0.50	3.0	20.3	1236
1×150	756/0.50	3.2	23.1	1570
1×185	925/0.50	3.4	24.6	1848
1×240	1221/0.50	3.5	27.6	2400
1×300	1525/0.50	3.6	30.9	2970
1×400	2013/0.50	3.7	36.5	4090



Impact Resistant



Highly Flexible



Cold Resistant

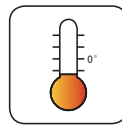

Soldering Heat Resistant

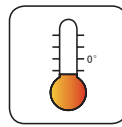

Low Temperature Resistant



Corona Resistant



Fire Retardant
NF C32-070-2.2(C1)
IEC 60332-3/EN50266



Flame Retardant
NF C32-070-2.1(C2)
IEC 60332-1/EN 50265-2-1



Low Corrosivity
EN 50267-2-2/NF C32-074
IEC 60754-2/NF C20-453



IRM 903 Fuel Oil Resistant



IRM 902 Mineral Oil Resistant

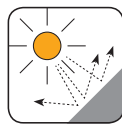

UV Resistant

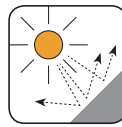

Ozone Resistant



Acid and Alkali Resistant

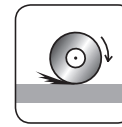

Abrasion Resistant



Low Smoke Emission
IEC 61034/NFC20-902
EN 50268/NF C32-073



Low Toxicity

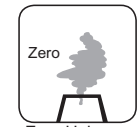

Zero Halogen
IEC 60754-1/NF C20-454
EN 50267-2-1



9GKW-AXplus-DW EMC 3.6/6KV Dual Wall Screened Single Core

Applications

Single core power and control cable designed for protected, fixed installation inside and outside railway vehicles for connecting fixed and moving parts in direct current and alternating voltage technology, especially converter technology.



Standard

- BS 6853 -1a
- DIN 5510-2 1-4
- NFF 16-101 F0

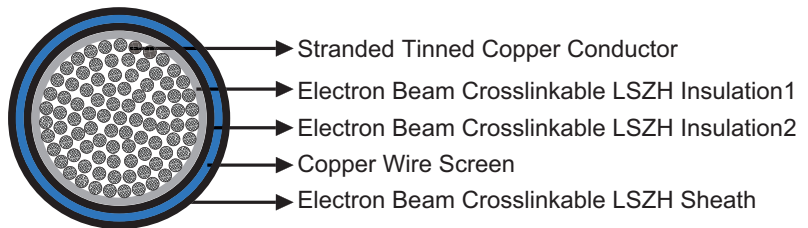

Construction

- **Conductors:** Circular Class 5 stranded tinned copper to IEC60228/VDE 0295.
- **Insulation1:** Electron beam crosslinkable LSZH compound.
- **Insulation2:** Electron beam crosslinkable LSZH compound.
- **Screen:** Copper wire screen.
- **Sheath:** Electron beam crosslinkable LSZH compound.

Electrical Characteristics at 20°C

Nominal Conductor Cross Section	mm ²	1.5	2.5	4.0	6.0	10	16	25	35	50
Maximum Conductor Resistance	Ω/km	13.7	8.21	5.09	3.39	1.95	1.24	0.795	0.565	0.393
Voltage Rating	KV	3.6/6								

Nominal Conductor Cross Section	mm ²	70	95	120	150	185	240	300	400
Maximum Conductor Resistance	Ω/km	0.277	0.21	0.164	0.132	0.108	0.0817	0.0654	0.0495
Voltage Rating	KV	3.6/6							



▾ Mechanical and Thermal Properties

Minimum Bending Radius: 4xOD (Static); 8xOD (Flexing)

Temperature Range: -60°C ~+120°C (Static); -40°C ~+90°C (Flexing)

Short Circuit Temperature: +280°C

▾ Dimensions and Weight

No. of cores& Nominal Conductor Cross Sectional Area No.×mm ²	Number and Nominal Diameter of Strands No/mm	Nominal Insulation Thickness mm	Nominal Overall Diameter mm	Nominal Weight kg/km
1×1.5	30/0.25	1.4	6.3	72
1×2.5	50/0.25	1.5	6.9	89
1×4	56/0.30	1.6	7.8	119
1×6	84/0.30	1.7	9.1	150
1×10	80/0.40	1.8	10.4	220
1×16	126/0.40	2.1	12.4	330
1×25	196/0.40	2.2	14.3	390
1×35	276/0.40	2.4	15.7	550
1×50	396/0.40	2.6	17.4	733
1×70	360/0.50	2.6	19.5	970
1×95	475/0.50	2.9	22.0	1216
1×120	608/0.50	3.0	24.7	1510
1×150	756/0.50	3.2	27.1	1900
1×185	925/0.50	3.4	29.1	2195
1×240	1221/0.50	3.5	32.3	2830
1×300	1525/0.50	3.6	35.6	3520
1×400	2013/0.50	3.7	38.3	4364



Impact Resistant



Highly Flexible

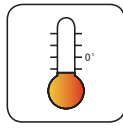

Cold Resistant

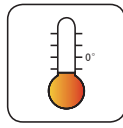

Soldering Heat Resistant

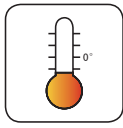

Low Temperature Resistant



Corona Resistant



Fire Retardant
NF C32-070-2.2(C1)
IEC 60332-3/EN50266



Flame Retardant
NF C32-070-2.1(C2)
IEC 60332-1/EN 50265-2-1



Low Corrosivity
EN 50267-2-2/NF C32-074
IEC 60754-2/NF C20-453



IRM 903 Fuel Oil Resistant



IRM 902 Mineral Oil Resistant

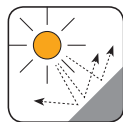

UV Resistant

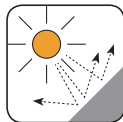

Ozone Resistant



Acid and Alkali Resistant

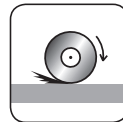

Abrasion Resistant



Low Smoke Emission
IEC 61034/NFC20-902
EN 50268/NF C32-073



Low Toxicity

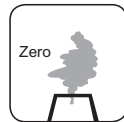

Zero Halogen
IEC 60754-1/NF C20-454
EN 50267-2-1



GKW-RW FE180 300/500V Thin Wall Single Core

Applications

Single core power and control cable designed for protected, fixed installation inside and outside railway vehicles for connecting fixed and moving parts in direct current and alternating voltage technology, especially converter technology.



Standard

- BS 6853 -1a
- DIN 5510-2 1-4
- NFF 16-101 F0

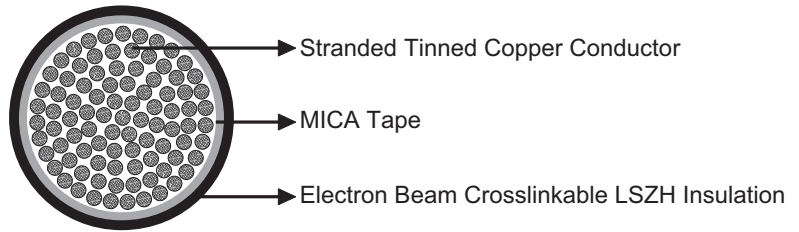

Construction

- **Conductors:** Circular Class 5 stranded tinned copper to IEC60228/VDE 0295.
- **Flame Barrier:** MICA tape.
- **Insulation:** Electron beam crosslinkable LSZH compound.

Electrical Characteristics at 20°C

Nominal Conductor Cross Section	mm ²	0.5	0.75	1	1.5	2.5
Maximum Conductor Resistance	Ω/km	40.1	26.7	20.0	13.7	8.21
Voltage Rating	KV	0.3/0.5				

Mechanical and Thermal Properties

Minimum Bending Radius: 4xOD (Static); 6xOD (Flexing)
 Temperature Range: -40°C ~+120°C (Static); -35°C ~+90°C (Flexing)
 Short Circuit Temperature: +280°C



Dimensions and Weight

No. of cores & Nominal Conductor Cross Sectional Area No. x mm ²	Number and Nominal Diameter of Strands No/mm	Nominal Insulation Thickness mm	Nominal Overall Diameter mm	Nominal Weight kg/km
1x0.5	16/0.2	0.3	2.00	8
1x0.75	24/0.2	0.3	2.25	10
1x1.0	32/0.2	0.35	2.50	14
1x1.5	30/0.25	0.35	2.80	18
1x2.5	50/0.25	0.35	3.20	29



Impact Resistant



Highly Flexible

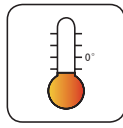

Cold Resistant



Soldering Heat Resistant



Fire Retardant
NF C32-070-2.2(C1)
IEC 60332-3/EN50266



Flame Retardant
NF C32-070-2.1(C2)
IEC 60332-1/EN 50265-2-1

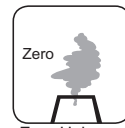

Zero Halogen
IEC 60754-1/NF C20-454
EN 50267-2-1



IRM 902 Mineral Oil Resistant

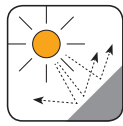

UV Resistant

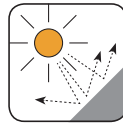

Ozone Resistant



Acid and Alkali Resistant



Low Corrosivity
EN 50267-2-2/NF C32-074
IEC 60754-2/NF C20-453



Low Toxicity



Low Smoke Emission
IEC 61034/NFC20-902
EN 50268/NF C32-073

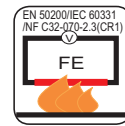

EN 50200/IEC 60331
NF C32-070-2.3(CR1)
FE
Insulation Integrity FE180



3GKW-SW FE180 0.6/1KV Standard Wall Single Core

Applications

Single core power and control cable designed for protected, fixed installation inside and outside railway vehicles for connecting fixed and moving parts in direct current and alternating voltage technology, especially converter technology.



Standard

- BS 6853 -1a
- DIN 5510-2 1-4
- NFF 16-101 F0

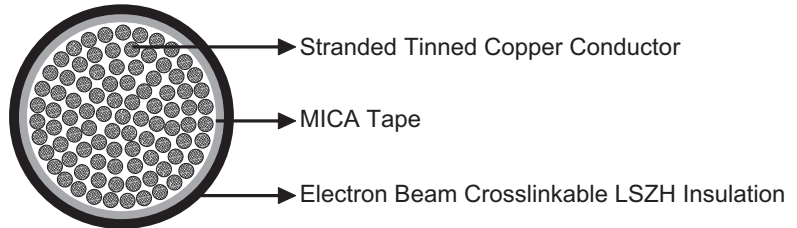

Construction

- **Conductors:** Circular Class 5 stranded tinned copper to IEC60228/VDE 0295.
- **Flame Barrier:** MICA tape.
- **Insulation:** Electron beam crosslinkable LSZH compound.

Electrical Characteristics at 20°C

Nominal Conductor Cross Section	mm ²	1	1.5	2.5	4.0	6.0	10	16
Maximum Conductor Resistance	Ω/km	20.0	13.7	8.21	5.09	3.39	1.95	1.24
Voltage Rating	KV	0.6/1						

Nominal Conductor Cross Section	mm ²	25	35	50	70	95	150
Maximum Conductor Resistance	Ω/km	0.795	0.565	0.393	0.277	0.21	0.132
Voltage Rating	KV	0.6/1					

Mechanical and Thermal Properties

Minimum Bending Radius: 4xOD (Static); 6xOD (Flexing)
 Temperature Range: -40°C ~+120°C (Static); -35°C ~+90°C (Flexing)
 Short Circuit Temperature: +280°C



Dimensions and Weight

No. of cores & Nominal Conductor Cross Sectional Area No. x mm ²	Number and Nominal Diameter of Strands No./mm	Nominal Insulation Thickness mm	Nominal Overall Diameter mm	Nominal Weight kg/km
1x1.0	32/0.2	0.55	3.15	19
1x1.5	30/0.25	0.55	3.40	24
1x2.5	50/0.25	0.60	4.05	36.6
1x4	56/0.3	0.65	4.60	52.5
1x6	84/0.3	0.70	5.30	73
1x10	80/0.4	0.80	6.35	122
1x16	126/0.4	0.90	8.15	182
1x25	196/0.40	1.0	9.65	263
1x35	276/0.40	1.1	10.80	365
1x50	396/0.40	1.2	12.80	530
1x70	360/0.50	1.3	15.10	730
1x95	475/0.50	1.4	17.00	930
1x150	756/0.50	1.6	21.30	1450



Impact Resistant



Highly Flexible

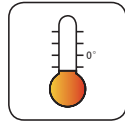

Cold Resistant

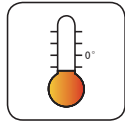

Soldering Heat Resistant



Fire Retardant
NF C32-070-2.2(C1)
IEC 60332-3/EN50266



Flame Retardant
NF C32-070-2.1(C2)
IEC 60332-1/EN 50265-2-1

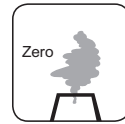

Zero Halogen
IEC 60754-1/NF C20-454
EN 50267-2-1



IRM 902 Mineral Oil Resistant

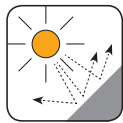

UV Resistant

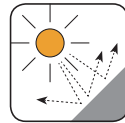

Ozone Resistant



Acid and Alkali Resistant



Low Corrosivity
EN 50267-2-2/NF C32-074
IEC 60754-2/NF C20-453



Low Toxicity



Low Smoke Emission
IEC 61034/NFC20-902
EN 50268/NF C32-073

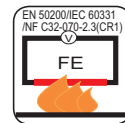

Insulation Integrity FE180
EN 50200/IEC 60331
NF C32-070-2.3(CR1)



4GKW-AXplus-DW FE180 1.8/3KV Dual Wall Single Core

Applications

Single core power and control cable designed for protected, fixed installation inside and outside railway vehicles for connecting fixed and moving parts in direct current and alternating voltage technology, especially converter technology.



Standard

- BS 6853 -1a
- DIN 5510-2 1-4
- NFF 16-101 F0

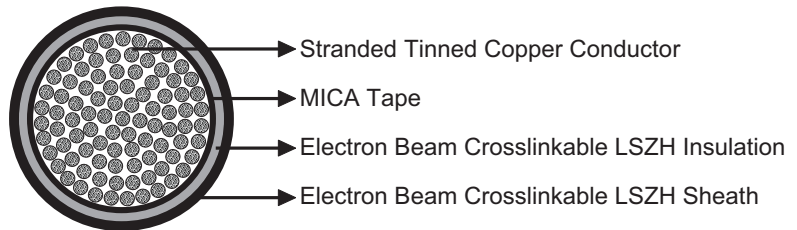

Construction

- **Conductors:** Circular Class 5 stranded tinned copper to IEC60228/VDE 0295.
- **Flame Barrier:** MICA tape.
- **Insulation:** Electron beam crosslinkable LSZH compound.
- **Sheath:** Electron beam crosslinkable LSZH compound.

Electrical Characteristics at 20°C

Nominal Conductor Cross Section	mm ²	1.5	2.5	4.0	6.0	10	16	25	35	50
Maximum Conductor Resistance	Ω/km	13.7	8.21	5.09	3.39	1.95	1.24	0.795	0.565	0.393
Voltage Rating	KV	1.8/3.0								

Nominal Conductor Cross Section	mm ²	70	95	120	150	185	240
Maximum Conductor Resistance	Ω/km	0.277	0.21	0.164	0.132	0.108	0.0817
Voltage Rating	KV	1.8/3.0					

Mechanical and Thermal Properties

Minimum Bending Radius: 4xOD (Static); 6xOD (Flexing)
 Temperature Range: -60°C ~+120°C (Static); -40°C ~+90°C (Flexing)
 Short Circuit Temperature: +280°C



Dimensions and Weight

No. of cores & Nominal Conductor Cross Sectional Area No. x mm ²	Number and Nominal Diameter of Strands No/mm	Nominal Insulation Thickness mm	Nominal Overall Diameter mm	Nominal Weight kg/km
1x1.5	30/0.25	1.05	4.90	38
1x2.5	50/0.25	1.15	5.35	50
1x4	56/0.30	1.25	6.10	88
1x6	84/0.30	1.30	7.00	93
1x10	80/0.40	1.30	8.10	142
1x16	126/0.40	1.15	9.30	210
1x25	196/0.40	1.50	10.8	290
1x35	276/0.40	1.50	12.1	400
1x50	396/0.40	1.60	13.8	561
1x70	360/0.50	1.70	16.2	760
1x95	475/0.50	1.90	18.0	980
1x120	608/0.50	1.60	20.2	1212
1x150	756/0.50	2.20	22.7	1520
1x185	925/0.50	2.40	24.6	1830
1x240	1221/0.50	2.50	27.6	2411



Impact Resistant



Highly Flexible

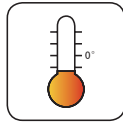

Cold Resistant



Soldering Heat Resistant

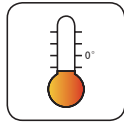

Low Temperature Resistant



Acid and Alkali Resistant



IRM 903 Fuel Oil Resistant



IRM 902 Mineral Oil Resistant

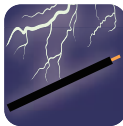

Corona Resistant



Fire Retardant
NF C32-070-2.2(C1)
IEC 60332-3/EN50266



Flame Retardant
NF C32-070-2.1(C2)
IEC 60332-1/EN 50265-2-1



Low Corrosivity
EN 50267-2-2/NF C32-074
IEC 60754-2/NF C20-453



UV Resistant

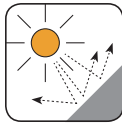

Ozone Resistant



Abrasion Resistant



Low Smoke Emission
IEC 61034/NFC20-902
EN 50268/NF C32-073



Low Toxicity

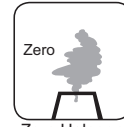

Zero Halogen
IEC 60754-1/NF C20-454
EN 50267-2-1

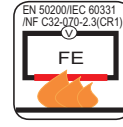

EN 50200/IEC 60331
/NF C32-070-2.3(CR1)
FE
Insulation Integrity FE180



FRA 145 Single Core

Applications

Single core cable with improved fire performance and very high resistance to temperature designed for internal wiring in lamps, heating appliances and distribution boxes in apparatus, mechanical and plant engineering, etc. Used for laying in tubes, surface wiring, direct in plaster or underneath it, as well in conduits.



Standard

- IEC 60754-1, EN 50267-2-1 (halogen free)
- IEC 60754-2, EN 50267-2-2 (no corrosive gases)
- NES 02-713, NFC 20-454 (no toxic gases)
- IEC 61034, EN 50268-2 (low smoke density)
- IEC 60332-1, EN 50265-2-1 (flame retardant)
- IEC 60332-3, EN 50266-2, NF C 32-070 (non-flame propagating)
- DIN 51900 (low fire load)

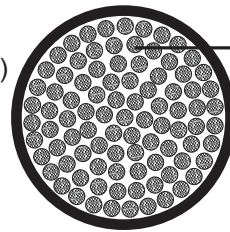

Stranded Tinned Copper Conductor

Electron Beam Crosslinkable Polyolefine Copolymer Insulation

Construction

- **Conductors:** Class 5 stranded tinned copper to IEC60228/VDE 0295.
- **Insulation:** Electron beam crosslinkable polyolefine copolymer.
- **Colour Code:** Various colours on request.

Electrical Characteristics at 20°C

Nominal Conductor Cross Section	mm ²	0.25	0.34	0.50	0.75	1.0	1.5	2.5	4.0	6.0	10	16
Maximum Conductor Resistance	Ω/km	85.9	57.2	40.1	26.7	20.0	13.7	8.21	5.09	3.39	1.95	1.24
Voltage Rating	V	300/500V (≤1mm ²); 450/750V (≥1.5mm ²)										

Nominal Conductor Cross Section	mm ²	25	35	50	70	95	120	150	185	240	300
Maximum Conductor Resistance	Ω/km	0.795	0.565	0.393	0.277	0.21	0.164	0.132	0.108	0.0817	0.0654
Voltage Rating	V	300/500V (≤1mm ²); 450/750V (≥1.5mm ²)									



▾ Mechanical and Thermal Properties

Minimum Bending Radius: 4xOD (Static); 6xOD (Flexing)

Temperature Range: -55°C ~+145°C (Static); -40°C ~+120°C (Flexing)

Short Circuit Temperature: +280°C

▾ Dimensions and Weight

No. of cores& Nominal Conductor Cross Sectional Area No.×mm ²	Number and Nominal Diameter of Strands No/mm	Nominal Insulation Thickness mm	Nominal Overall Diameter mm	Nominal Weight kg/km
1×0.25	19/0.13	0.5	1.5	5
1×0.34	19/0.15	0.5	1.7	6
1×0.50	16/0.20	0.5	1.8	8
1×0.75	24/0.20	0.6	2.2	11
1×1.0	30/0.20	0.6	2.5	14
1×1.5	30/0.25	0.6	2.7	21
1×2.5	50/0.25	0.7	3.4	33
1×4.0	56/0.30	0.8	4.1	48
1×6.0	84/0.30	0.9	5.2	67
1×10.0	80/0.40	1.0	6.4	112
1×16.0	126/0.40	1.1	7.5	172
1×25.0	196/0.40	1.3	9.2	262
1×35.0	276/0.40	1.3	10.4	362
1×50.0	396/0.40	1.6	12.5	512
1×70.0	360/0.50	1.6	14.7	710
1×95.0	475/0.50	1.8	16.4	937
1×120.0	608/0.50	1.8	18.2	1159
1×150.0	756/0.50	1.9	20.8	1447
1×185.0	925/0.50	2.0	22.5	1790
1×240.0	1221/0.50	2.2	25.7	2318
1×300.0	1525/0.50	2.4	28.3	2897



Impact Resistant



Highly Flexible



Weather Resistant

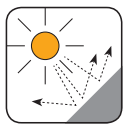

UV Resistant



Fire Retardant
NF C32-070-2.2(C1)
IEC 60332-3/EN50266



Flame Retardant
NF C32-070-2.1(C2)
IEC 60332-1/EN 50265-2-1



Low Corrosivity
EN 50267-2-2/NF C32-074
IEC 60754-2/NF C20-453



Low Toxicity



Low Smoke Emission
IEC 61034/NFC20-902
EN 50268/NF C32-073

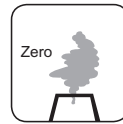

Zero Halogen
IEC 60754-1/NF C20-454
EN 50267-2-1



FRA 145/S Multicore

Applications

Multicore cable with improved fire performance and very high resistance to temperature designed for internal wiring in lamps, heating appliances and distribution boxes in apparatus, mechanical and plant engineering, etc. Used for fixed and flexible application in dry, humid and wet rooms.



Standard

- IEC 60754-1, EN 50267-2-1 (halogen free)
- IEC 60754-2, EN 50267-2-2 (no corrosive gases)
- NES 02-713, NFC 20-454 (no toxic gases)
- IEC 61034, EN 50268-2 (low smoke density)
- IEC 60332-1, EN 50265-2-1 (flame retardant)
- IEC 60332-3, EN 50266-2, NF C 32-070 (non-flame propagating)
- DIN 51900 (low fire load)

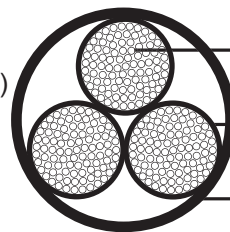

Stranded Tinned Copper Conductor

Electron Beam Crosslinkable Polyolefine Copolymer Insulation

Electron Beam Crosslinkable Polyolefine Copolymer Sheath

Construction

- **Conductors:** Class 5 stranded tinned copper to IEC60228/VDE 0295.
- **Insulation:** Electron beam crosslinkable polyolefine copolymer.
- **Sheath:** Electron beam crosslinkable polyolefine copolymer.

Electrical Characteristics at 20°C

Nominal Conductor Cross Section	mm ²	0.50	0.75	1.0	1.5	2.5	4.0	6.0
Maximum Conductor Resistance	Ω/km	40.1	26.7	20.0	13.7	8.21	5.09	3.39
Voltage Rating	V	300/500V (≤1mm ²); 450/750V (≥1.5mm ²)						

Mechanical and Thermal Properties

Minimum Bending Radius: 4xOD (Static); 6xOD (Flexing)

Temperature Range: -55°C ~+145°C (Static); -40°C ~+120°C (Flexing)

Short Circuit Temperature: +280°C



▾ Dimensions and Weight

No. of cores & Nominal Conductor Cross Sectional Area No. x mm ²	Number and Nominal Diameter of Strands No/mm	Nominal Insulation Thickness mm	Nominal Overall Diameter mm	Nominal Weight kg/km
2x0.5	16/0.20	0.5	5.1	38
3x0.5	16/0.20	0.5	5.5	46
4x0.5	16/0.20	0.5	5.9	55
5x0.5	16/0.20	0.5	6.7	68
6x0.5	16/0.20	0.5	7.1	77
7x0.5	16/0.20	0.5	7.8	93
8x0.5	16/0.20	0.5	8.6	102
10x0.5	16/0.20	0.5	9.4	130
12x0.5	16/0.20	0.5	9.4	125
14x0.5	16/0.20	0.5	10.0	145
16x0.5	16/0.20	0.5	10.7	166
2x0.75	24/0.20	0.6	5.9	52
3x0.75	24/0.20	0.6	6.2	61
4x0.75	24/0.20	0.6	6.9	75
5x0.75	24/0.20	0.6	7.7	94
6x0.75	24/0.20	0.6	8.3	107
7x0.75	24/0.20	0.6	9.1	127
8x0.75	24/0.20	0.6	10.2	144
10x0.75	24/0.20	0.6	11.1	186
14x0.75	24/0.20	0.6	11.7	203
16x0.75	24/0.20	0.6	12.5	233
1x1	30/0.20	0.6	3.9	25
2x1	30/0.20	0.6	6.3	50
3x1	30/0.20	0.6	6.8	67
4x1	30/0.20	0.6	7.4	87
5x1	30/0.20	0.6	8.4	107
6x1	30/0.20	0.6	8.9	124
7x1	30/0.20	0.6	10.2	152
8x1	30/0.20	0.6	11.0	177
10x1	30/0.20	0.6	12.1	222
14x1	30/0.20	0.6	12.7	252
2x1.5	30/0.25	0.6	7.8	71
3x1.5	30/0.25	0.6	8.3	96
4x1.5	30/0.25	0.6	9.1	123
5x1.5	30/0.25	0.6	10.1	156
7x1.5	30/0.25	0.6	12.1	224
10x1.5	30/0.25	0.6	15.0	314
12x1.5	30/0.25	0.6	15.0	346
16x1.5	30/0.25	0.6	16.8	452
25x1.5	30/0.25	0.6	21.7	702
2x2.5	50/0.25	0.7	9.1	102



No. of cores & Nominal Conductor Cross Sectional Area No. × mm ²	Number and Nominal Diameter of Strands No./mm	Nominal Insulation Thickness mm	Nominal Overall Diameter mm	Nominal Weight kg/km
3×2.5	50/0.25	0.7	9.9	145
4×2.5	50/0.25	0.7	10.9	189
5×2.5	50/0.25	0.7	12.2	235
7×2.5	50/0.25	0.7	14.6	344
4×4	56/0.30	0.8	12.8	268
5×4	56/0.30	0.8	14.2	334
5×6	84/0.30	0.9	15.8	494



Impact Resistant



Highly Flexible

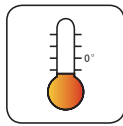

Weather Resistant

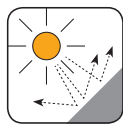

UV Resistant



Fire Retardant
NF C32-070-2.2(C1)
IEC 60332-3/EN50266



Flame Retardant
NF C32-070-2.1(C2)
IEC 60332-1/EN 50265-2-1



Low Corrosivity
EN 50267-2-2/NF C32-074
IEC 60754-2/NF C20-453



Low Toxicity



Low Smoke Emission
IEC 61034/NFC20-902
EN 50268/NF C32-073

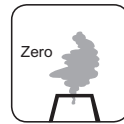

Zero Halogen
IEC 60754-1/NF C20-454
EN 50267-2-1



FRA 145/S EMC Screened Multicore

Applications

Multicore cable with improved fire performance and very high resistance to temperature designed for internal wiring in lamps, heating appliances and distribution boxes in apparatus, mechanical and plant engineering, etc. Used for fixed and flexible application in dry, humid and wet rooms.



Standard

- IEC 60754-1, EN 50267-2-1 (halogen free)
- IEC 60754-2, EN 50267-2-2 (no corrosive gases)
- NES 02-713, NFC 20-454 (no toxic gases)
- IEC 61034, EN 50268-2 (low smoke density)
- IEC 60332-1, EN 50265-2-1 (flame retardant)
- IEC 60332-3, EN 50266-2, NF C 32-070 (non-flame propagating)
- DIN 51900 (low fire load)

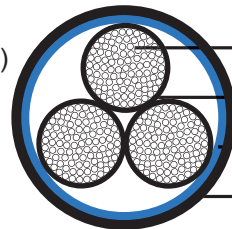

- Stranded Tinned Copper Conductor
- Electron Beam Crosslinkable Polyolefine Copolymer Insulation
- Copper Wire Screen
- Electron Beam Crosslinkable Polyolefine Copolymer Sheath

Construction

- **Conductors:** Class 5 stranded tinned copper to IEC60228/VDE 0295.
- **Insulation:** Electron beam crosslinkable polyolefine copolymer.
- **Screen:** Copper wire screen.
- **Sheath:** Electron beam crosslinkable polyolefine copolymer.

Electrical Characteristics at 20°C

Nominal Conductor Cross Section	mm ²	0.50	0.75	1.0	1.5	2.5	4.0
Maximum Conductor Resistance	Ω/km	40.1	26.7	20.0	13.7	8.21	5.09
Voltage Rating	V	300/500V (≤1mm ²); 450/750V (≥1.5mm ²)					



▾ Mechanical and Thermal Properties

Minimum Bending Radius: 4xOD (Static); 6xOD (Flexing)

Temperature Range: -55°C ~+145°C (Static); -40°C ~+120°C (Flexing)

Short Circuit Temperature: +280°C

▾ Dimensions and Weight

No. of cores & Nominal Conductor Cross Sectional Area No. × mm ²	Number and Nominal Diameter of Strands No./mm	Nominal Insulation Thickness mm	Nominal Overall Diameter mm	Nominal Weight kg/km
1×0.5	16/0.20	0.5	3.7	23
2×0.5	16/0.20	0.5	5.6	45
3×0.5	16/0.20	0.5	6.1	59
4×0.5	16/0.20	0.5	6.7	72
5×0.5	16/0.20	0.5	7.3	86
6×0.5	16/0.20	0.5	7.9	102
7×0.5	16/0.20	0.5	8.4	118
8×0.5	16/0.20	0.5	9.0	133
10×0.5	16/0.20	0.5	10.0	157
12×0.5	16/0.20	0.5	10.0	164
1×0.75	24/0.20	0.6	4.0	28
2×0.75	24/0.20	0.6	6.7	66
3×0.75	24/0.20	0.6	7.1	78
4×0.75	24/0.20	0.6	7.7	94
5×0.75	24/0.20	0.6	8.5	113
6×0.75	24/0.20	0.6	8.9	132
7×0.75	24/0.20	0.6	9.9	158
8×0.75	24/0.20	0.6	10.6	181
10×0.75	24/0.20	0.6	11.5	209
12×0.75	24/0.20	0.6	11.5	219
14×0.75	24/0.20	0.6	12.2	251
16×0.75	24/0.20	0.6	12.9	279
19×0.75	24/0.20	0.6	14.5	347
21×0.75	24/0.20	0.6	15.3	385
1×1	30/0.20	0.6	4.2	33
2×1	30/0.20	0.6	7.2	79
3×1	30/0.20	0.6	7.7	89
4×1	30/0.20	0.6	8.3	113
5×1	30/0.20	0.6	9.0	134
6×1	30/0.20	0.6	9.5	156
7×1	30/0.20	0.6	10.9	187
8×1	30/0.20	0.6	11.4	218
10×1	30/0.20	0.6	12.5	253
12×1	30/0.20	0.6	12.5	266



No. of cores & Nominal Conductor Cross Sectional Area No. x mm ²	Number and Nominal Diameter of Strands No/mm	Nominal Insulation Thickness mm	Nominal Overall Diameter mm	Nominal Weight kg/km
1x1.5	30/0.25	0.6	4.8	43
2x1.5	30/0.25	0.6	8.4	105
3x1.5	30/0.25	0.6	8.9	119
4x1.5	30/0.25	0.6	9.9	163
5x1.5	30/0.25	0.6	10.7	183
6x1.5	30/0.25	0.6	11.5	219
7x1.5	30/0.25	0.6	12.7	273
8x1.5	30/0.25	0.6	13.7	305
10x1.5	30/0.25	0.6	15.0	309
2x2.5	50/0.25	0.7	9.9	157
3x2.5	50/0.25	0.7	10.5	198
4x2.5	50/0.25	0.7	11.5	236
5x2.5	50/0.25	0.7	12.8	287
7x2.5	50/0.25	0.7	15.5	430
4x4	56/0.30	0.8	13.2	317
5x4	56/0.30	0.8	14.5	376



Impact Resistant



Highly Flexible

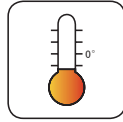

Weather Resistant

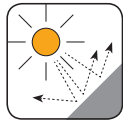

UV Resistant



Fire Retardant
NF C32-070-2.2(C1)
IEC 60332-3/EN50266



Flame Retardant
NF C32-070-2.1(C2)
IEC 60332-1/EN 50265-2-1



Low Corrosivity
EN 50267-2-2/NF C32-074
IEC 60754-2/NF C20-453



Low Toxicity



Low Smoke Emission
IEC 61034/NFC20-902
EN 50268/NF C32-073

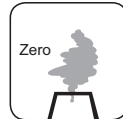

Zero Halogen
IEC 60754-1/NF C20-454
EN 50267-2-1



FRA 155 Single Core

Applications

Single core cable with very high resistance to temperature designed for internal wiring in lamps, heating appliances and distribution boxes in apparatus, mechanical and plant engineering, etc.



Standard

- IEC 60332-1, EN 50265-2-1 (flame retardant)
- EN 50266-2 (non-flame propagating)

Construction

- **Conductors:** Class 5 stranded tinned copper to IEC60228/VDE 0295.
- **Insulation:** Electron beam crosslinkable polyolefine copolymer.
- **Colour Code:** Various colours on request.

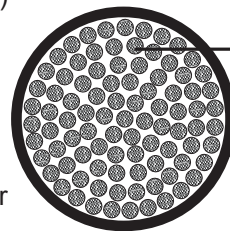

Stranded Tinned Copper Conductor

Electron Beam Crosslinkable
 Polyolefine Copolymer Insulation

Electrical Characteristics at 20°C

Nominal Conductor Cross Section	mm ²	0.25	0.34	0.50	0.75	1.0	1.5	2.5	4.0	6.0	10	16
Maximum Conductor Resistance	Ω/km	85.9	57.2	40.1	26.7	20.0	13.7	8.21	5.09	3.39	1.95	1.24
Voltage Rating	V	450/750V (≤0.5mm ²); 600/1000V (>0.5mm ²)										

Nominal Conductor Cross Section	mm ²	25	35	50	70	95	120	150	185	240
Maximum Conductor Resistance	Ω/km	0.795	0.565	0.393	0.277	0.21	0.164	0.132	0.108	0.0817
Voltage Rating	V	450/750V (≤0.5mm ²); 600/1000V (>0.5mm ²)								

Mechanical and Thermal Properties

Minimum Bending Radius: 4xOD (Static); 6xOD (Flexing)

Temperature Range: -55°C ~+155°C (Static); -40°C ~+120°C (Flexing)

Short Circuit Temperature: +280°C



Dimensions and Weight

No. of cores & Nominal Conductor Cross Sectional Area No. × mm ²	Number and Nominal Diameter of Strands No/mm	Nominal Insulation Thickness mm	Nominal Overall Diameter mm	Nominal Weight kg/km
1×0.25	19/0.13	0.5	1.5	4
1×0.34	19/0.15	0.5	1.7	5
1×0.50	16/0.20	0.5	1.8	7
1×0.75	24/0.20	0.6	2.2	10
1×1.0	30/0.20	0.6	2.5	13
1×1.5	30/0.25	0.6	2.7	20
1×2.5	50/0.25	0.7	3.4	31
1×4.0	56/0.30	0.8	4.1	46
1×6.0	84/0.30	0.9	5.2	65
1×10.0	80/0.40	1.0	6.4	110
1×16.0	126/0.40	1.1	7.5	165
1×25.0	196/0.40	1.3	9.2	250
1×35.0	276/0.40	1.3	10.4	345
1×50.0	396/0.40	1.6	12.5	550
1×70.0	360/0.50	1.6	14.7	780
1×95.0	475/0.50	1.8	16.4	1010
1×120.0	608/0.50	1.8	18.2	1280
1×150.0	756/0.50	1.9	20.8	1420
1×185.0	925/0.50	2.0	22.5	1710
1×240.0	1221/0.50	2.2	25.7	2250



Impact Resistant



Highly Flexible



Weather Resistant

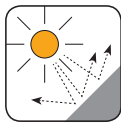

UV Resistant



Fire Retardant
NF C32-070-2.2(C1)
IEC 60332-3/EN50266



Flame Retardant
NF C32-070-2.1(C2)
IEC 60332-1/EN 50265-2-1



FRA 155S Oil Resistant Single Core

Applications

Single core cable with very high resistance to temperature designed for internal wiring in lamps, heating appliances and distribution boxes in apparatus, mechanical and plant engineering, etc.



Standard

- IEC 60332-1, EN 50265-2-1 (flame retardant)
- EN 50266-2 (non-flame propagating)

Construction

- **Conductors:** Class 5 stranded tinned copper to IEC60228/VDE 0295.
- **Insulation:** Electron beam crosslinkable polyolefine copolymer.
- **Colour Code:** Various colours on request.

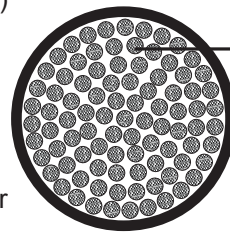

Stranded Tinned Copper Conductor

Electron Beam Crosslinkable
 Polyolefine Copolymer Insulation

Electrical Characteristics at 20°C

Nominal Conductor Cross Section	mm ²	0.50	0.75	1.0	1.5	2.5	4.0	6.0
Maximum Conductor Resistance	Ω/km	40.1	26.7	20.0	13.7	8.21	5.09	3.39
Voltage Rating	V	450/750V (≤0.5mm ²); 600/1000V (>0.5mm ²)						

Mechanical and Thermal Properties

Minimum Bending Radius: 4xOD (Static); 6xOD (Flexing)

Temperature Range: -55°C ~+155°C (Static); -40°C ~+120°C (Flexing)

Short Circuit Temperature: +280°C



▾ Dimensions and Weight

No. of cores & Nominal Conductor Cross Sectional Area No. × mm ²	Number and Nominal Diameter of Strands No./mm	Nominal Insulation Thickness mm	Nominal Overall Diameter mm	Nominal Weight kg/km
1×0.50	16/0.20	0.4	1.7	7
1×0.75	24/0.20	0.5	2.2	11
1×1.0	30/0.20	0.6	2.5	15
1×1.5	30/0.25	0.6	2.7	19
1×2.5	50/0.25	0.7	3.5	30
1×4.0	56/0.30	0.8	4.2	45
1×6.0	84/0.30	0.9	5.2	66



Oil Resistant



Impact Resistant



Highly Flexible

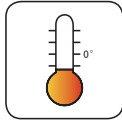

Weather Resistant

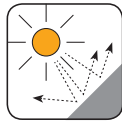

UV Resistant



Fire Retardant
NF C32-070-2.2(C1)
IEC 60332-3/EN50266



Flame Retardant
NF C32-070-2.1(C2)
IEC 60332-1/EN 50265-2-1



FRA 155/S Multicore

Applications

Multicore cable with very high resistance to temperature designed for internal wiring in lamps, heating appliances and distribution boxes in apparatus, mechanical and plant engineering, etc. Used for fixed and flexible application in dry, humid and wet rooms.



Standard

- IEC 60332-1, EN 50265-2-1 (flame retardant)
- EN 50266-2 (non-flame propagating)

Construction

- **Conductors:** Class 5 stranded tinned copper to IEC60228/VDE 0295.
- **Insulation:** Electron beam crosslinkable polyolefine copolymer.
- **Sheath:** Electron beam crosslinkable polyolefine copolymer.

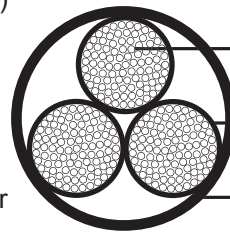

- Stranded Tinned Copper Conductor
- Electron Beam Crosslinkable Polyolefine Copolymer Insulation
- Electron Beam Crosslinkable Polyolefine Copolymer Sheath

Electrical Characteristics at 20°C

Nominal Conductor Cross Section	mm ²	0.25	0.50	0.75	1.0	1.5	2.5
Maximum Conductor Resistance	Ω/km	85.9	40.1	26.7	20.0	13.7	8.21
Voltage Rating	V	450/750V (≤0.5mm ²); 600/1000V (>0.5mm ²)					

Mechanical and Thermal Properties

Minimum Bending Radius: 4xOD (Static); 6xOD (Flexing)
 Temperature Range: -55°C ~+155°C (Static); -40°C ~+120°C (Flexing)
 Short Circuit Temperature: +280°C



▾ Dimensions and Weight

No. of cores & Nominal Conductor Cross Sectional Area No. × mm ²	Number and Nominal Diameter of Strands No/mm	Nominal Insulation Thickness mm	Nominal Overall Diameter mm	Nominal Weight kg/km
4×0.25	19/0.13	0.5	5.4	33
2×0.5	16/0.20	0.5	5.2	30
3×0.5	16/0.20	0.5	5.6	40
8×0.5	16/0.20	0.5	8.8	102
16×0.5	16/0.20	0.5	10.7	166
3×0.75	24/0.20	0.6	6.7	59
4×0.75	24/0.20	0.6	7.5	80
2×1	30/0.20	0.6	7.0	61
3×1	30/0.20	0.6	7.6	77
2×1.5	30/0.25	0.6	7.5	66
3×1.5	30/0.25	0.6	7.9	92
4×1.5	30/0.25	0.6	8.8	117
5×1.5	30/0.25	0.6	10.1	150
3×2.5	50/0.25	0.7	9.9	145
4×2.5	50/0.25	0.7	11.0	186
5×2.5	50/0.25	0.7	12.0	223



Impact Resistant



Highly Flexible



Weather Resistant

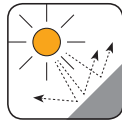

UV Resistant



Fire Retardant
NF C32-070-2.2(C1)
IEC 60332-3/EN50266



Flame Retardant
NF C32-070-2.1(C2)
IEC 60332-1/EN 50265-2-1



FRA 155/S EMC Screened Multicore

Applications

Multicore cable with very high resistance to temperature designed for internal wiring in lamps, heating appliances and distribution boxes in apparatus, mechanical and plant engineering, etc. Used for fixed and flexible application in dry, humid and wet rooms.



Standard

- IEC 60332-1, EN 50265-2-1 (flame retardant)
- EN 50266-2 (non-flame propagating)

Construction

- **Conductors:** Class 5 stranded tinned copper to IEC60228/VDE 0295.
- **Insulation:** Electron beam crosslinkable polyolefine copolymer.
- **Screen:** Copper wire screen.
- **Sheath:** Electron beam crosslinkable polyolefine copolymer.

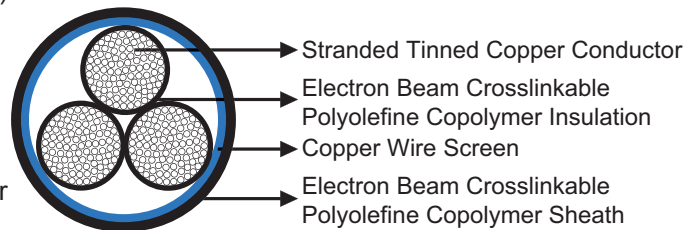

Electrical Characteristics at 20°C

Nominal Conductor Cross Section	mm ²	0.25	0.50	1.5	2.5
Maximum Conductor Resistance	Ω/km	85.9	40.1	13.7	8.21
Voltage Rating	V	450/750V (≤0.5mm ²); 600/1000V (>0.5mm ²)			

Mechanical and Thermal Properties

Minimum Bending Radius: 4xOD (Static); 6xOD (Flexing)
 Temperature Range: -55°C ~+155°C (Static); -40°C ~+120°C (Flexing)
 Short Circuit Temperature: +280°C



▾ Dimensions and Weight

No. of cores & Nominal Conductor Cross Sectional Area No. x mm ²	Number and Nominal Diameter of Strands No/mm	Nominal Insulation Thickness mm	Nominal Overall Diameter mm	Nominal Weight kg/km
2x0.25	19/0.13	0.5	5.1	34
6x0.25	19/0.13	0.5	7.0	67
4x2x0.25	19/0.13	0.5	14.0	277
4x0.5	16/0.20	0.5	7.6	76
16x0.5	16/0.20	0.5	11.6	206
3x1.5	30/0.25	0.6	8.7	119
10x1.5	30/0.25	0.6	14.7	332
16x1.5	30/0.25	0.6	22.0	740
8x2.5	50/0.25	0.7	18.0	498
9x2.5	50/0.25	0.7	18.6	518



Impact Resistant



Highly Flexible

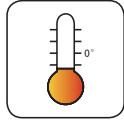

Weather Resistant

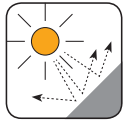

UV Resistant



Fire Retardant
NF C32-070-2.2(C1)
IEC 60332-3/EN50266



Flame Retardant
NF C32-070-2.1(C2)
IEC 60332-1/EN 50265-2-1



Ordering Information For GKW Cables

▾ Cable Code Designation

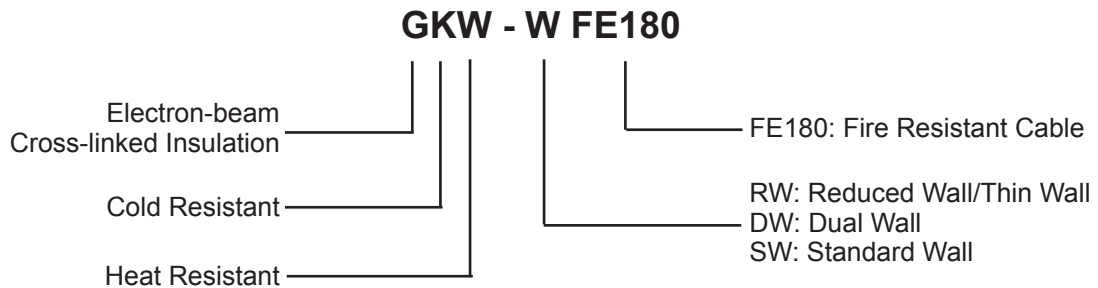
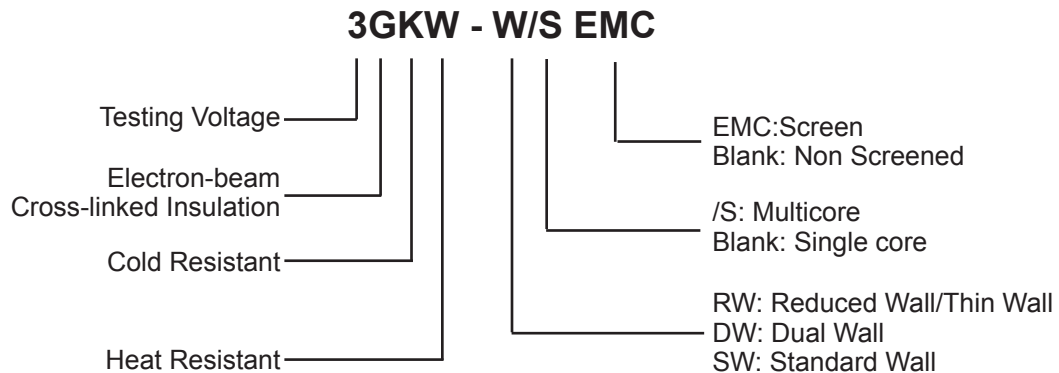

Ordering Information For High Temperature Cables

▾ Cable Code Designation

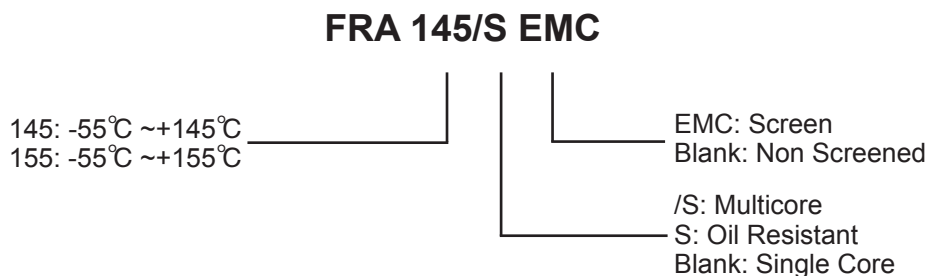

UNITED KINGDOM

Marchants Industrial Centre,
Mill Lane, Laughton, Lewes,
East Sussex, BN8 6AJ, UK
Tel: 44-207-4195087
Fax: 44-207-8319489
Email: sales@caledonian-cables.co.uk
Website: www.caledonian-cables.co.uk

HONG KONG

Unit B 22/F CMA Building
64-66 Connaught Road Central
Hong Kong
Tel: 852-36527508
Fax: 852-35834834
Email: hk@caledonian-cables.co.uk
hk@caledonian-cables.com

SHANGHAI

Room 3501, CITIC Square, 1168 Nanjing Xi Lu,
Shanghai 200041, P.R. China
Tel: 86-21-51119178
Fax: 86-21-52524616
Email: cn@caledonian-cables.co.uk
shanghai@caledonian-cables.com